

Heegaard splittings of Graph manifolds

Jennifer Schultens

May 26, 2003

Abstract

Let M be a totally orientable graph manifold with characteristic submanifold \mathcal{T} and let $M = V \cup_S W$ be a Heegaard splitting. We prove that S is standard. In particular, S can be isotoped so that for each vertex manifold N of M , $S \cap N$ is either horizontal, pseudohorizontal, vertical or pseudovertical.

1 Introduction

The subject of this investigation is the structure of Heegaard splittings of graph manifolds. This investigation continues the work begun in [20], [21], [13] and [22]. Since the publication of those papers, new techniques have been added to the repertoire of those interested in describing the structure of Heegaard splittings. These include the idea of untelescoping a weakly reducible Heegaard splitting into a generalized strongly irreducible Heegaard splitting due to M. Scharlemann and A. Thompson. They also include the Rubinstein-Scharlemann graphic, as employed by D. Cooper and M. Scharlemann in [6]. These insights have not left the investigation here unaffected. We hope that their role here is a tribute to proper *affinage*¹. (The structural theorem given here has been promised for rather a long time.) A similar theorem was announced by J.H.Rubinstein.

The main theorem is the following, for definitions see sections 2 and 3:

Theorem 1.1. *Let M be a totally orientable graph manifold. If $M = V \cup_S W$ is an irreducible Heegaard splitting, then S is standard.*

More specifically, S can be isotoped so that for each vertex manifold N of M , $S \cap N$ is either horizontal, pseudohorizontal or vertical and such that for each edge manifold $(\text{torus}) \times I \subset \mathcal{E}$, $S \cap ((\text{torus}) \times I)$ is characterized by one of the following:

1) *After isotopy, $S \cap ((\text{torus}) \times I)$ is obtained from a collection of incompressible annuli by ambient 1-surgery along a collection of arcs each of which is isotopic into $(\text{torus}) \times \{\text{point}\}$.*

2) *There is a pair of simple closed curves $c, c' \subset (\text{torus})$ such that $c \cap c'$ consists of a single point $p \in (\text{torus})$ and $V \cap ((\text{torus}) \times I)$ is a collar of $(c \times \{0\}) \cup (p \times I) \cup (c' \times \{1\})$.*

¹This is a French noun describing the maturing process of a cheese.

The graph manifolds considered here are totally orientable, that is, they are orientable 3-manifolds and for each vertex manifold the underlying surface of the orbit space is orientable. It follows from [10, VI.34] that an incompressible surface can be isotoped to be either horizontal or vertical in each vertex manifold of a totally orientable graph manifold. In conjunction with the notion of untelescoping a weakly reducible Heegaard splitting into a strongly irreducible generalized Heegaard splitting, this observation reduces the investigation at hand to the investigation of strongly irreducible Heegaard splittings of generalized graph manifolds (for definitions, see below).

In the investigation of strongly irreducible Heegaard splittings of generalized graph manifolds, the nice properties of strongly irreducible Heegaard splittings often reduce this investigation to a study of the behaviour of the Heegaard splittings near the characteristic submanifolds. In this context, a theorem of D. Cooper and M. Scharlemann completes the description of this behaviour, see Proposition 7.15 and Proposition 7.23. This theorem may be found in [6, Theorem 4.2].

The theorem here is purely structural in the sense that it describes the various ways in which a Heegaard splitting may be constructed. In particular, it enables a computation of Heegaard genus, i.e., the smallest possible genus of a Heegaard splitting, for totally orientable graph manifolds. To compute this genus, one need merely consider the finitely many possible constructions, compute the corresponding Euler characteristics, and find the extremal value. This line of thought is pursued in [24], where the genus of a certain class of totally orientable graph manifolds is compared to the rank, i.e., the least number of generators, of the fundamental group of these manifolds.

The theorem leaves open the question of classification. There will be some, though probably not too many, cases in which the various constructions are isotopic. More interestingly, there may be larger scale isotopies. I.e., there may be two Heegaard splittings of a graph manifold that are isotopic but not via an isotopy fixing their intersection with the decomposing tori. Clearly, this leaves much room for further investigation.

The global strategy is as follows: By Theorem 3.10, a Heegaard splitting is the amalgamation of the strongly irreducible Heegaard splittings arising in any of its weak reductions. Thus, one begins with a Heegaard splitting of a graph manifold. One then considers a weak reduction of this Heegaard splitting. Cutting along the incompressible surfaces in the weak reduction yields generalized graph manifolds with strongly irreducible Heegaard splittings. One analyzes the possible strongly irreducible Heegaard splittings of generalized graph manifolds. Finally, one considers all possibilities arising in the amalgamation of strongly irreducible Heegaard splittings of generalized graph manifolds.

I wish to thank the many colleagues who have reminded me that a complete report on this investigation is past due. Among these are Ian Agol, Hugh Howards, Yoav Moriah, Marty Scharlemann, Yo'av Rieck, Eric Sedgwick and Richard Weidmann. I also wish to thank the MPIM-Bonn where part of this work was done. This work was supported in part by the grant NSF-DMS 0203680.

2 Totally orientable graph manifolds

For standard definitions pertaining to knot theory see for instance [4], [11] or [15]. For 3-manifolds see [9] or [10]. Note that the terminology for graph manifolds has not been standardized.

Definition 2.1. *A Seifert manifold is a compact 3-manifold that admits a foliation by circles.*

For a more concrete definition, see for instance [10]. The fact that the simple definition here is in fact equivalent to more concrete definitions follows from [7].

Definition 2.2. *The circles in the foliation of a Seifert fibered space M are called fibers. The natural projection that sends each fiber to a point is denoted by $p : M \rightarrow Q$. The quotient space Q is called the base orbifold of M . A fiber f is called an exceptional fiber if nearby fibers wind around f more than once. Otherwise, f is called a regular fiber. The image under p of a regular fiber is called a regular point and the image under p of an exceptional fiber is called an exceptional point.*

The base orbifold is in fact a surface. This follows from standard facts about foliations in conjunction with [7]. It also follows that there will be only finitely many exceptional fibers.

Definition 2.3. *For Y a submanifold of X , we denote an open regular neighborhood of Y in X by $\eta(Y, X)$, or simply by $\eta(Y)$, if there is no ambiguity concerning the ambient manifold. Similarly, we denote a closed regular neighborhood by $N(Y, X)$, or simply by $N(Y)$, if there is no ambiguity concerning the ambient manifold.*

Definition 2.4. *A surface S in a Seifert fibered space M is vertical if it consists of fibers. It is horizontal if it intersects all fibers transversely. It is pseudohorizontal if there is a fiber $f \subset M$ such that $S \cap (M \setminus \eta(f))$ is horizontal and $S \cap N(f)$ is a collar of f .*

It follows that a horizontal surface in a Seifert fibered space M orbifold covers the base orbifold of M .

Definition 2.5. *A Seifert fibered space is totally orientable if it is orientable as a 3-manifold and has an orientable base orbifold.*

We are now ready to define graph manifolds.

Definition 2.6. *A graph manifold is a 3-manifold M modelled on a finite graph Γ as follows:*

- 1) *Each vertex v of Γ corresponds to a Seifert fibered space, denoted by M_v and called a vertex manifold;*
- 2) *Each edge e of Γ corresponds to a 3-manifold homeomorphic to $(\text{torus}) \times S^1$, denoted by M_e and called an edge manifold;*
- 3) *If an edge e is incident to a vertex v , then this incidence is realized by an identification of a boundary component of M_e with a boundary component of M_v via a homeomorphism.*

A graph manifold is totally orientable if each vertex manifold is totally orientable.

The union of edge manifolds in M is also called the characteristic submanifold of M . It is denoted by \mathcal{E} . The image of a boundary component of the characteristic submanifold of M is a torus called a decomposing torus. It is denoted by \mathcal{T} .

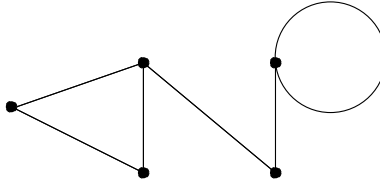

Figure 1: A model graph for a graph manifold

A decomposing torus is, of course, also the image of a boundary component of a vertex manifold. But the converse is not always true.

Remark 2.7. *We have placed no restrictions on the homeomorphism that identifies a boundary component of an edge manifold with a boundary component of a vertex manifold. Thus according to this definition, there will be Seifert fibered spaces that admit a description as a graph manifold with non empty characteristic submanifold. From the point of view of the investigation here, this is often a useful way to think of such a Seifert fibered space. See [26].*

Definition 2.8. *A boundary component of a vertex manifold M_v of a graph manifold M that is also a boundary component of M is called an exterior boundary component of M_v . We denote the union of exterior boundary components of M_v by $\partial_E M_v$.*

3 Untelescoping and amalgamation

We here give the basic definitions concerning Heegaard splittings, strongly irreducible Heegaard splittings, untelescoping and amalgamations. Theorem 3.10 below is crucial to the global strategy employed in our investigation.

Definition 3.1. *A compression body is a 3-manifold W obtained from a connected closed orientable surface S by attaching 2-handles to $S \times \{0\} \subset S \times I$ and capping off any resulting 2-sphere boundary components. We denote $S \times \{1\}$ by $\partial_+ W$ and $\partial W \setminus \partial_+ W$ by $\partial_- W$. Dually, a compression body is a connected orientable 3-manifold obtained from a (not necessarily connected) closed orientable surface $\partial_- W \times I$ or a 3-ball by attaching 1-handles.*

In the case where $\partial_- W = \emptyset$ (i.e., in the case where a 3-ball was used in the dual construction of W), we also call W a handlebody. If $W = \partial_- W \times I$, we say that W is a trivial compression body.

Definition 3.2. *A spine of a compression body W is a 1-complex X such that W collapses to $\partial_- W \cup X$.*

Definition 3.3. *A set of defining disks for a compression body W is a set of disks $\{D_1, \dots, D_n\}$ properly imbedded in W with $\partial D_i \subset \partial_+ W$ for $i = 1, \dots, n$ such that the result of cutting W along $D_1 \cup \dots \cup D_n$ is homeomorphic to $\partial_- W \times I$ or to a 3-ball in the case that W is a handlebody.*

Definition 3.4. A Heegaard splitting of a 3-manifold M is a decomposition $M = V \cup_S W$ in which V, W are compression bodies, $V \cap W = \partial_+ V = \partial_+ W = S$ and $M = V \cup W$. We call S the splitting surface or Heegaard surface.

The notion of strong irreducibility of a Heegaard splitting was introduced by A. Casson and C. McA. Gordon in [5] and has proven extremely useful.

Definition 3.5. A Heegaard splitting $M = V \cup_S W$ is strongly irreducible if for any pair of essential disks $D \subset V$ and $E \subset W$, $\partial D \cap \partial E \neq \emptyset$.

Recall also the following related definitions:

Definition 3.6. A Heegaard splitting $M = V \cup_S W$ is reducible if there exists a pair of essential disks $D \subset V$ and $E \subset W$ such that $\partial D = \partial E$. If $M = V \cup_S W$ is not reducible, then it is irreducible.

A Heegaard splitting $M = V \cup_S W$ is stabilized if there exists a pair of essential disks $D \subset V$ and $E \subset W$ such that $|\partial D \cap \partial E| = 1$.

Though all compact 3-manifolds admit Heegaard splittings, many do not admit strongly irreducible Heegaard splitting. This fact prompted M. Scharlemann and A. Thompson to introduce the following notion of generalized Heegaard splittings.

Definition 3.7. A generalized Heegaard splitting of a compact orientable 3-manifold M is a decomposition $M = (V_1 \cup_{S_1} W_1) \cup_{F_1} (V_2 \cup_{S_2} W_2) \cup_{F_2} \cdots \cup_{F_{m-1}} (V_m \cup_{S_m} W_m)$ such that each of the V_i and W_i is a union of compression bodies with $\partial_+ V_i = S_i = \partial_+ W_i$ and $\partial_- W_i = F_i = \partial_- V_{i+1}$.

We say that a generalized Heegaard splitting is strongly irreducible if each Heegaard splitting of a component of $M_i = V_i \cup_{S_i} W_i$ is strongly irreducible and each F_i is incompressible in M . We will denote $\cup_i F_i$ by \mathcal{F} and $\cup_i S_i$ by \mathcal{S} . The surfaces in \mathcal{F} are called the thin levels and the surfaces in \mathcal{S} the thick levels.

Let $M = V \cup_S W$ be an irreducible Heegaard splitting. We may think of M as being obtained from $\partial_- V \times I$ by attaching all 1-handles in V (dual definition of compression body) followed by all 2-handles in W (standard definition of compression body), followed, perhaps, by 3-handles. An untelescoping of $M = V \cup_S W$ is a rearrangement of the order in which the 1-handles of V and the 2-handles of W are attached yielding a generalized Heegaard splitting. A weak reduction of $M = V \cup_S W$ is an untelescoping that is strongly irreducible.

The Main Theorem in [18] implies the following:

Theorem 3.8. Let M be an irreducible 3-manifold. Any Heegaard splitting $M = V \cup_S W$ has a weak reduction.

Definition 3.9. Let N, L be 3-manifolds with R a closed subsurface of ∂N , and S a closed subsurface of ∂L , such that R is homeomorphic to S via a homeomorphism h . Further, let $(U_1, U_2), (V_1, V_2)$ be Heegaard splittings of N, L such that $N(R) \subset U_1, N(S) \subset V_1$. Then, for some $R' \subset \partial N \setminus R$ and $S' \subset \partial L \setminus S$, $U_1 = N(R \cup R') \cup (1 - \text{handles})$ and $V_1 = N(S \cup S') \cup (1 - \text{handles})$. Here $N(R)$ is homeomorphic to $R \times I$ via a homeomorphism f and $N(S)$ is homeomorphic to $S \times I$ via a homeomorphism g . Let \sim be the equivalence relation on $N \cup L$ generated by

(1) $x \sim y$ if $x, y \in \eta(R)$ and $p_1 \cdot f(x) = p_1 \cdot f(y)$,

(2) $x \sim y$ if $x, y \in \eta(S)$ and $p_1 \cdot g(x) = p_1 \cdot g(y)$,

(3) $x \sim y$ if $x \in R$, $y \in S$ and $h(x) = y$,

where p_1 is projection onto the first coordinate. Perform isotopies so that for D an attaching disk for a 1-handle in U_1 , D' an attaching disk for a 1-handle in V_1 , $[D] \cap [D'] = \emptyset$. Set $M = (N \cup L) / \sim$, $W_1 = (U_1 \cup V_2) / \sim$, and $W_2 = (U_2 \cup V_1) / \sim$. In particular, $(N(R) \cup N(S) / \sim) \cong R, S$. Then $W_1 = V_2 \cup N(R') \cup (1 - \text{handles})$, where the 1-handles are attached to $\partial_+ V_2$ and connect $\partial N(R')$ to $\partial_+ V_2$, and hence W_1 is a compression body. Analogously, W_2 is a compression body. So (W_1, W_2) is a Heegaard splitting of M . The splitting (W_1, W_2) is called the amalgamation of (U_1, U_2) and (V_1, V_2) along R, S via h .

Theorem 3.8 together with [20, Proposition 2.8] implies the following:

Theorem 3.10. *Suppose $M = V \cup_S W$ is an irreducible Heegaard splitting and $M = (V_1 \cup_{S_1} W_1) \cup_{F_1} (V_2 \cup_{S_2} W_2) \cup_{F_2} \cdots \cup_{F_{m-1}} (V_m \cup_{S_m} W_m)$ a weak reduction of $M = V \cup_S W$. Then the amalgamation of $M = (V_1 \cup_{S_1} W_1) \cup_{F_1} (V_2 \cup_{S_2} W_2) \cup_{F_2} \cdots \cup_{F_{m-1}} (V_m \cup_{S_m} W_m)$ along $F_1 \cup \cdots \cup F_{m-1}$ is $M = V \cup_S W$.*

One of the nice properties of strongly irreducible Heegaard splittings is apparent in the following lemma which is a deep fact and is proven, for instance, in [23, Lemma 6].

Lemma 3.11. *Suppose $M = V \cup_S W$ is a strongly irreducible Heegaard splitting and $P \subset M$ an essential incompressible surface. Then S can be isotoped so that $S \cap P$ consists only of curves essential in both S and P .*

4 Incompressible surfaces and generalized graph manifolds

In the arguments that follow, we employ the ideas of untelescoping and amalgamation. In this section, we describe the incompressible surfaces that arise in a weak reduction of a Heegaard splitting. We then describe the 3-manifolds that result from cutting a graph manifold along such incompressible surfaces. We will call these 3-manifolds generalized graph manifolds. Later, we will consider the strongly irreducible Heegaard splittings on these generalized graph manifolds.

Remark 4.1. *An edge manifold of a totally orientable graph manifold M is homeomorphic to $(\text{torus}) \times I$. There are infinitely many distinct foliations of $(\text{torus}) \times I$ as an annulus bundle over the circle. The incompressible surfaces in $(\text{torus}) \times I$ are tori isotopic to $(\text{torus}) \times \{\text{point}\}$, annuli isotopic to the annular fibers in the foliations of $(\text{torus}) \times I$ as an annulus bundle over the circle and annuli parallel into $\partial((\text{torus}) \times I)$.*

Lemma 4.2. *Let F be an incompressible surface in a totally orientable graph manifold M . Then F may be isotoped so that in each edge manifold it consists of incompressible tori and essential annuli and in each vertex manifold it is either horizontal or vertical.*

Proof: Let \mathcal{T} be the collection of decomposing tori for M . Since F and \mathcal{T} are incompressible, F may be isotoped so that $F \cap \mathcal{T}$ consists only of curves essential in both F and \mathcal{T} . We may assume that this has been done in such a way that the number of components in $F \cap \mathcal{T}$ is minimal. Let N be a component of $M \setminus \mathcal{T}$, then $F \cap N$ is incompressible. Furthermore, no component of $F \cap N$ is an annulus parallel into \mathcal{T} .

Suppose $F \cap N$ is boundary compressible in N . Let \hat{D} be a boundary compressing disk for $F \cap N$. Then $\partial \hat{D} = a \cup b$, with $a \subset \partial N$ and $b \subset F$. Since $F \cap \mathcal{T}$ consists only of curves essential in both F and \mathcal{T} , the component A of $\partial N \setminus (F \cap \partial N)$ that contains a is an annulus. Let $B(\hat{D})$ be a bicollar of \hat{D} . Then $\partial B(\hat{D})$ has two components, \hat{D}_0, \hat{D}_1 . Consider the disk $D = (A \setminus (A \cap B(\hat{D}))) \cup \hat{D}_0 \cup \hat{D}_1$. Since F is incompressible, D must be parallel to a disk in F , but this implies that the number of components of $F \cap \mathcal{T}$ is not minimal, a contradiction. Thus, $F \cap N$ is boundary incompressible in N .

If N is an edge manifold, then $F \cap N$ is as required by Remark 4.1. If N is a vertex manifold, then [10, VI.34] allows three possibilities for $F \cap N$: 1) $F \cap N$ is vertical; 2) $F \cap N$ is horizontal; or 3) $F \cap N$ is the boundary of a twisted I -bundle over a horizontal surface \hat{F}^N in N . For a boundary incompressible surface in N this latter possibility would imply that there is a nonorientable horizontal surface \hat{F}^N in C . In particular, \hat{F}^N would be a cover of the base orbifold. But this is impossible. Hence $F \cap N$ is either horizontal or vertical. Hence $F \cap N$ is as required. \square

The following definition describes the 3-manifolds that result when a totally orientable graph manifold is cut along incompressible surfaces.

Definition 4.3. *A generalized graph manifold is a 3-manifold M modelled on a finite graph Γ as follows:*

- 1) *Each vertex v of Γ corresponds either to a Seifert fibered space or to a 3-manifold homeomorphic to (compact surface) $\times [0, 1]$. This manifold is denoted by M_v and called a vertex manifold.*
- 2) *Each edge e of Γ corresponds either to a 3-manifold homeomorphic to (torus) $\times I$ or to a 3-manifold homeomorphic to (annulus) $\times I$. This manifold is denoted by M_e and called an edge manifold.*
- 3) *If the edge manifold M_e is homeomorphic to (torus) $\times I$ and e is incident to a vertex v , then this incidence is realized by an identification of a boundary component of M_e with a boundary component of M_v . In particular, M_v must be Seifert fibered.*
- 4) *If the edge manifold M_e is homeomorphic to (annulus) $\times I$ and e is incident to a vertex v , then this incidence is realized by an identification of a component of $(\partial(\text{annulus})) \times I$, with a subannulus of ∂M_v . If M_v is Seifert fibered, then this subannulus of ∂M_v consists of fibers of M_v . If M_v is homeomorphic to (compact surface) $\times I$, then this subannulus is a component of $(\partial(\text{compact surface})) \times I$.*
- 5) *If a vertex manifold M_v is homeomorphic to (compact surface) $\times I$, then the valence of v equals the number of components of $(\partial(\text{compact surface})) \times I$. I.e., each component of $(\partial(\text{compact surface})) \times I$ is identified with a subannulus of the boundary of an edge manifold.*

A generalized graph manifold is totally orientable if each vertex manifold that is

Seifert fibered is totally orientable and each vertex manifold that is not Seifert fibered is homeomorphic to (compact orientable surface) $\times I$.

The union of edge manifolds in M is also called the characteristic submanifold of M . It is denoted by \mathcal{E} . The image of a torus or annulus, respectively, along which an identification took place is called a decomposing torus or decomposing annulus, respectively. The union of decomposing tori and annuli is denoted by \mathcal{T} .

Consider the case in which an edge manifold $M_e = (\text{torus}) \times [0, 1]$ of a graph manifold is cut along an incompressible torus $T = (\text{torus}) \times \{\text{point}\}$. When M_e is cut along T , the remnants of M_e are $(\text{torus}) \times [0, \frac{1}{2}]$ and $(\text{torus}) \times [\frac{1}{2}, 1]$. Each of these remnants forms a collar of a vertex manifold. A foliation of (torus) by circles may be chosen in such a way that the Seifert fibration of the vertex manifold extends across the remnant. We may thus ignore these remnants, as we do in the above definition of generalized graph manifolds. This facilitates the discussion of strongly irreducible Heegaard splittings of generalized graph manifolds. Later, when considering amalgamations of strongly irreducible Heegaard splittings of generalized graph manifolds, we will have to reconsider these remnants.

Definition 4.4. *A portion of the boundary of a vertex manifold M_v of a generalized graph manifold M that is contained in ∂M is called an exterior boundary component of M_v . We denote the union of exterior boundary components of M_v by $\partial_E M_v$.*

5 Examples of Heegaard splittings

In this section we describe some examples of Heegaard splittings for graph manifolds and generalized graph manifolds. The following definition facilitates describing the structure of certain surfaces.

Definition 5.1. *Let F be a surface in a 3-manifold M and α an arc with interior in $M \setminus F$ and endpoints on F . Let $C(\alpha)$ be a collar of α in M . The boundary of $C(\alpha)$ consists of an annulus A together with two disks D_1, D_2 , which we may assume to lie in F . We call the process of replacing F by $(F \setminus (D_1 \cup D_2)) \cup A$ performing ambient 1-surgery on F along α .*

The process of ambient 1-surgery on a surface along an arc is sometimes informally referred to as “attaching a tube”.

Example 5.2. *Let Q be a closed orientable surface. The standard Heegaard splitting of $Q \times \mathbb{S}^1$ may be constructed in more than one way. In particular, consider a small disk $D \subset Q$ and a collection Γ of arcs that cut $Q \setminus D$ into a disk. Let S be the result of performing ambient 1-surgery on $\partial D \times \mathbb{S}^1$ along $\Gamma \times \{\text{point}\}$. Then S is the splitting surface of a Heegaard splitting $Q \times \mathbb{S}^1 = V \cup_S W$ (for details, [20]). See Figure 2. One of the handlebodies is $((\text{shaded disk}) \times \mathbb{S}^1) \cup N(\text{dashed arcs})$.*

The same Heegaard splitting of $Q \times \mathbb{S}^1$ may be obtained in another way: Partition \mathbb{S}^1 into two intervals I_1, I_2 that meet in their endpoints. Consider two distinct points $p, q \in Q$. Then the surface obtained by performing ambient 1-surgery on $Q \times (I_1 \cap I_2)$ along $(p \times I_1) \cup (q \times I_2)$ is isotopic to S above.

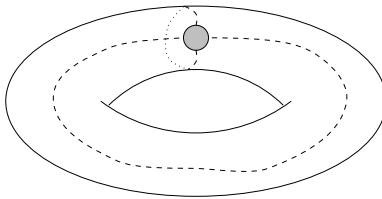

Figure 2: Schematic for Heegaard splitting of $Q \times \mathbb{S}^1$

One does not usually consider $Q \times \mathbb{S}^1$ as a graph manifold with non empty characteristic submanifold. But we may do so, somewhat artificially, by choosing an essential circle c in Q , and declaring a collar of $c \times \mathbb{S}^1$ to be the characteristic submanifold. From this point of view, $Q \times \mathbb{S}^1$ is a graph manifold modelled on a graph with a single edge and either one vertex, in the case that c is non separating, or two vertices, in the case that c is separating.

When we think of $Q \times \mathbb{S}^1$ as a graph manifold, we may choose p, q on c . Then we see that S is horizontal in the vertex manifold(s) and has the required structure in the edge manifold.

The fact that this Heegaard splitting can be constructed either from a vertical torus or from horizontal surfaces via ambient 1-surgery is likely to be a very special feature. But there are no general techniques for detecting the sort of global isotopies that allow this to happen.

The Heegaard splitting described turns out to be the only irreducible Heegaard splitting for a manifold of the form $(\text{closed orientable surface}) \times \mathbb{S}^1$. This fact is the main theorem of [20]. The construction can be generalized to Seifert fibered spaces to provide the canonical Heegaard splittings for totally orientable Seifert fibered spaces, see [1] and [13]. The Heegaard splittings arising from this construction have been termed vertical. This terminology has created some confusion, because the splitting surface of a vertical Heegaard splitting is not vertical as a surface. Here we will continually focus on the splitting surface. In particular, we will want to distinguish between surfaces that are vertical and surfaces that are the splitting surface of a vertical Heegaard splitting. For this reason, we will augment the existing terminology and refer to the splitting surface of a vertical Heegaard splitting as “pseudovertical”.

We recall the definition of a vertical Heegaard splitting for a Seifert fibered space. Because the structure of Heegaard splittings for totally orientable Seifert fibered spaces has been completely described by in [13], we may restrict our attention to Seifert fibered spaces with non empty boundary in the definition below.

Definition 5.3. *Let M be a Seifert fibered space with $\partial M \neq \emptyset$. Denote the base orbifold of M by O . Denote the exceptional fibers of M by f_1, \dots, f_n and the corresponding exceptional points in O by e_1, \dots, e_n . Denote the boundary components of M by B_1, \dots, B_m and the corresponding boundary components of O by b_1, \dots, b_m ,*

Partition f_1, \dots, f_n into two subsets: f_1, \dots, f_i , the fibers that will lie in V and f_{i+1}, \dots, f_n , the fibers that will lie in W . Then partition B_1, \dots, B_m into two subsets: B_1, \dots, B_j , the boundary components that will lie in V and B_{j+1}, \dots, B_m , the boundary components that will lie in W .

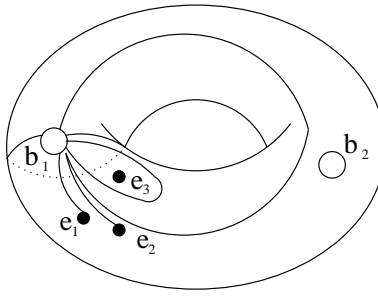

Figure 3: Schematic for a vertical Heegaard splitting of a Seifert fibered space

We may assume that $j \geq 1$, for otherwise we may interchange the roles of V and W in the construction below. Let Γ be a collection of arcs in O each with at least one endpoint on b_1 such that $O \setminus \Gamma$ is a regular neighborhood of $e_{i+1} \cup \dots \cup e_n \cup b_{j+1} \cup \dots \cup b_m$ or of a point, if this set is empty. See Figure 3.

Set $V = N(f_1 \cup \dots \cup f_i \cup B_1 \cup \dots \cup B_j \cup \Gamma)$ and set $W = \text{closure}(M \setminus V)$. Set $S = \partial_+ V = \partial_+ W$. Then $M = V \cup_S W$ is a Heegaard splitting. (For details, see [21] or [13].) A Heegaard splitting of a Seifert fibered space with non empty boundary constructed in this manner is called a vertical Heegaard splitting. A pseudovertical surface is a surface that is the splitting surface of a vertical Heegaard splitting.

A little more work is required to extend this notion to the setting of graph manifolds. Here we consider the intersection of a Heegaard splitting of a generalized graph manifold with a vertex manifold that is a Seifert fibered space. Denote the Heegaard splitting by $M = V \cup_S W$ and the vertex manifold by M_v . Here $S \cap M_v$ is not necessarily connected. Furthermore, $S \cap M_v$ has boundary. A concrete description of all possible such surfaces would be quite extensive. For this reason, we give the following, purely structural, definition:

Definition 5.4. Let $M = V \cup_S W$ be a Heegaard splitting of a generalized graph manifold with non empty characteristic submanifold. Let M_v be a Seifert fibered vertex manifold of M . We say that $S \cap M_v$ is pseudovertical if the following hold:

- 1) There is a collection of vertical annuli and tori $\mathcal{A} \subset M_v$.
- 2) There is a collection of arcs Γ in the interior of M_v such that each endpoint of each arc in Γ lies in \mathcal{A} and such that Γ projects to a collection of disjoint imbedded arcs.
- 3) $S \cap M_v$ is obtained from \mathcal{A} by ambient 1-surgery along Γ .

The assumption that $M = V \cup_S W$ is a Heegaard splitting places strong restrictions on S . If $S \cap M_v$ is pseudovertical, then $S \cap (\partial M_v \setminus \partial_E M_v)$ consists of vertical curves. Thus $V \cap (\partial M_v \setminus \partial_E M_v)$ and $W \cap (\partial M_v \setminus \partial_E M_v)$ consist of annuli. Each such annulus is either a spanning annulus in V or W , or it has both boundary components in S .

Consider the result of cutting a compression body V along an annulus A with $\partial A \subset \partial_+ V$. If the annulus is inessential, then the effect is nil. If the annulus is essential, then the result is again a, possibly disconnected, compression body, see [23, Lemma 2]. If the annulus is a spanning annulus, then the result is not quite a compression body, but it is a compact 3-manifold of the form $((\text{compact surface}) \times I) \cup (1 - \text{handles})$.

The only way this can happen, given the structure of $S \cap M_v$, is if the components of $V \cap M_v$ and $W \cap M_v$ are constructed from vertical solid tori and perhaps components homeomorphic to $(\text{annulus}) \times \mathbb{S}^1$ by attaching “horizontal” 1-handles. For more concrete computations, see [24].

It is a non trivial fact that for Seifert fibered spaces the two definitions of pseudovertical surfaces coincide. This follows from [20, Proposition 2.10] via Lemma 7.1 (an adaptation of the central argument in [21]) along with Lemma 7.3. For an illustration, see the final remarks in the example below.

Example 5.5. *Let M be a Seifert fibered space with base orbifold a disk and with two exceptional fibers f_1, f_2 . Let T be a boundary parallel torus and let α be an arc connecting T to itself that projects to an imbedded arc that runs between the two exceptional points. Let S be the result of performing ambient 1-surgery on T along α . Then S is the splitting surface of a Heegaard splitting of $M = V \cup_S W$ (see [13]).*

Now consider two copies M_1, M_2 of M with Heegaard splittings $M_i = V_i \cup_{S_i} W_i$. We may assume that $\partial M_1 \subset V_1$ and $\partial M_2 \subset W_2$. Now identify ∂M_1 and ∂M_2 to obtain a 3-manifold M . Amalgamate M_1 and M_2 along $\partial M_1, \partial M_2$ to obtain a Heegaard splitting $M = V \cup_S W$. The result is schematically indicated in Figure 4. The circle corresponds to a vertical torus. The splitting surface of the Heegaard splitting is obtained by performing ambient 1-surgery on this torus along arcs in M corresponding to the dashed arcs.

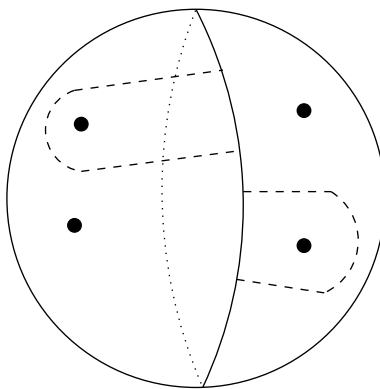

Figure 4: Schematic for Heegaard splitting after amalgamation

The manifold M obtained when ∂M_1 and ∂M_2 are identified is a graph manifold modelled on a graph with two vertices and one edge connecting the two vertices. The vertex manifolds are slightly shrunken versions of M_1 and M_2 . The edge manifold is a collar of the image of ∂M_1 and ∂M_2 in M . Figure 5 indicates that, after a small isotopy, S is pseudovertical in each of the two vertex manifolds and is incompressible in the edge manifold.

If the homeomorphism that identifies ∂M_1 with ∂M_2 is fiberpreserving, then M is in fact a Seifert fibered space. In this case S is isotopic to the surface indicated in Figure 6. This surface is obtained by performing ambient 1-surgery along two arcs corresponding to the dashed arcs on the two vertical tori corresponding to the two solid circles.

The above construction can be generalized to arbitrary graph manifolds. The

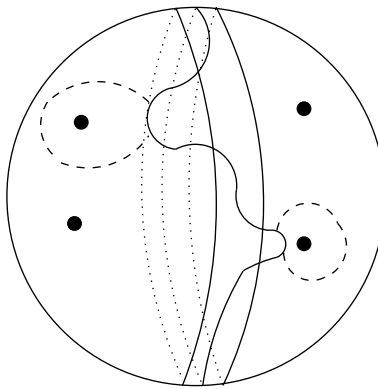

Figure 5: Schematic for Heegaard splitting of a graph manifold

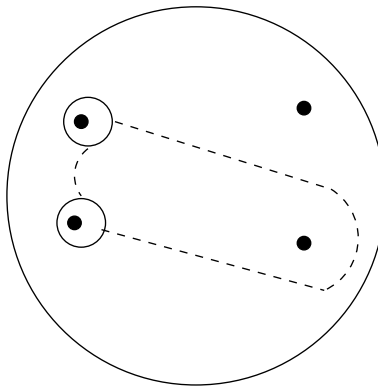

Figure 6: Schematic for Heegaard splitting of a Seifert fibered space

resulting Heegaard splittings can be considered the canonical Heegaard splittings of graph manifolds.

The following two examples illustrate the more peculiar Heegaard splittings that arise under special circumstances.

Example 5.6. *Let N be a Seifert fibered space with base orbifold the sphere and with four exceptional fibers f_1, \dots, f_4 with carefully chosen invariants: $\frac{1}{2}, \frac{1}{2}, \frac{1}{2}, \frac{l}{2l+1}$. Here $N \setminus \eta(f_4)$ is a Seifert fibered manifold with boundary and hence fibers over the circle. More specifically, it fibers as a once punctured torus bundle over the circle. By partitioning the circle into two intervals I_1, I_2 that meet in their endpoints, we obtain a decomposition $N \setminus \eta(f_4) = V' \cup_S W'$ with $V' = (\text{once punctured torus}) \times I_1$, $W' = (\text{once punctured torus}) \times I_2$ and $S' = \text{two once punctured tori}$.*

Note that this decomposition is not a Heegaard splitting in the sense used here as S' is not closed. Now the carefully chosen invariants guarantee that the boundary of a meridian disk of $N(f_4)$ meets $\partial V'$ in a single arc. In particular, $V = V' \cup N(f_4)$ is also a handlebody (of genus two). Setting $W = W'$, this defines a Heegaard splitting $N = V \cup_S W$. The splitting surface of this Heegaard splitting is a horizontal surface away from $N(f_4)$. And after a small isotopy, $S \cap N(f_4)$ is a collar of f_4 . Thus S is pseudohorizontal.

Example 5.7. *Let Q be a once punctured torus. Set $M_i = Q \times \mathbb{S}^1$ for $i = 1, 2$. Partition \mathbb{S}^1 into two intervals I_1, I_2 meeting in their endpoints. Set $V_i = Q \times I_1 \subset M_i$*

and $W_i = Q \times I_2 \subset M_i$. Let $T_i = \partial M_i$ and $c_i = \partial Q \times \{\text{point}\} \subset T_i$. Identify T_1 and T_2 via a homeomorphism so that $|c_1 \cap c_2| = 1$. Then V_1 and V_2 meet in a (square) disk, hence $V = V_1 \cup V_2$ is a handlebody. Similarly, $W = W_1 \cup W_2$ is a handlebody. Set $S = \partial V = \partial W$, then $M = V \cup_S W$ is a Heegaard splitting of $M = M_1 \cup_{T_1=T_2} M_2$.

Here M is a graph manifold modelled on a graph with two vertices and one edge connecting the two vertices. Its characteristic submanifold is a collar of $T_1 = T_2$. In the vertex manifolds, S is horizontal. In the edge manifold, S has a very specific structure.

Definition 5.8. Let M be a generalized graph manifold with characteristic submanifold \mathcal{E} . Let $M = V \cup_S W$ be a Heegaard splitting. We say that $M = V \cup_S W$ is standard if S can be isotoped so that for each vertex manifold M_v of M , $S \cap M_v$ is either horizontal, pseudohorizontal, vertical or pseudovertical and such that for each edge manifold M_e of M , $S \cap M_e$ is characterized by one of the following:

- 1) $M_e = (\text{torus}) \times I$ or $M_e = (\text{annulus}) \times I$ and, after isotopy, $S \cap M_e$ is obtained from a collection of incompressible annuli by ambient 1-surgery along a collection of arcs each of which is isotopic into $(\text{torus}) \times \{\text{point}\}$ or $(\text{annulus}) \times \{\text{point}\}$, respectively.
- 2) $M_e = (\text{torus}) \times I$ and there is a pair of simple closed curves $c, c' \subset (\text{torus})$ such that $c \cap c'$ consists of a single point $p \in (\text{torus})$ and $V \cap ((\text{torus}) \times I)$ is a collar of $(c \times \{0\}) \cup (p \times I) \cup (c' \times \{1\})$.

6 The active component

In this section we consider a generalized graph manifold W . We show that if $M = V \cup_S W$ is a strongly irreducible Heegaard splitting, then S may be isotoped so that it is incompressible away from a single vertex or edge manifold of M .

Lemma 6.1. Let M be a generalized graph manifold with characteristic submanifold \mathcal{T} . Let $M = V \cup_S W$ be a strongly irreducible Heegaard splitting. Let \mathcal{D}_V be a collection of defining disks for V and \mathcal{D}_W a collection of defining disks for W . There is a vertex or edge manifold N of M so that, after isotopy, each outermost disk component of both $\mathcal{D}_V \setminus (\mathcal{T} \cap \mathcal{D}_V)$ and of $\mathcal{D}_W \setminus (\mathcal{T} \cap \mathcal{D}_W)$ lies in N . Moreover, for each vertex or edge manifold $\tilde{N} \neq N$, $S \cap \tilde{N}$ is incompressible.

Proof: Isotope S so that $\mathcal{T} \cap S$ consists only of curves essential in both \mathcal{T} and S . Furthermore, assume that the isotopy has been chosen so that $|\mathcal{T} \cap S|$ is minimal subject to this condition. Suppose that D' is an outermost subdisk of $\mathcal{D}_V \setminus (\mathcal{T} \cap \mathcal{D}_V)$. Let N be the vertex or edge manifold of M containing D' . Then either D' is a disk in the interior of V or D' meets an annular component A of $V \cap \partial N$. In case of the latter, $\partial D'$ meets A in a single arc, a . Let D'' be the disk obtained by cutting A along a , adding two copies of D' and isotoping the result to be a properly imbedded disk in V . The assumption that $|\mathcal{T} \cap S|$ be minimal guarantees that D'' is an essential disk in V . Thus in both cases, there is an essential disk properly imbedded in V that lies in the interior of N , we refer to this disk as D .

Similarly, consider an outermost subdisk of $\mathcal{D}_W \setminus (\mathcal{T} \cap \mathcal{D}_W)$. The above argument shows that in a vertex or edge manifold N' of M , there is an essential disk E properly

imbedded in W . Since $M = V \cup_S W$ is strongly irreducible, D must meet E , hence the vertex or edge manifold N' must coincide with the vertex or edge manifold N .

It follows that for each vertex or edge manifold $\tilde{N} \neq N$, $S \cap \tilde{N}$ is incompressible. \square

Definition 6.2. *If M is a generalized graph manifold, with a strongly irreducible Heegaard splitting $M = V \cup_S W$, then the vertex or edge manifold N as in Lemma 6.1 is called the active component of $M = V \cup_S W$.*

7 What happens in the active component?

The possibilities for the active component depend on the type of the active component. There are five possibilities. We discuss each in turn.

7.1 Seifert fibered vertex manifold with exterior boundary

We first consider the case in which the active component of $M = V \cup_S W$ is a vertex manifold M_v that is a Seifert fibered space and that has exterior boundary. There are two cases, that in which the characteristic submanifold of M is non empty and that in which it is empty, i.e., M is Seifert fibered with non empty boundary.

Lemma 7.1. *Under these circumstances each exceptional fiber of M_v is a core of either V or W .*

Proof: This is [21, Lemma 4.1], the central argument in [21]. \square

The isotopy performed in [21, Lemma 4.1] takes place within a small regular neighborhood of a saturated annulus. In particular, the isotopy can here be performed entirely within M_v . The only requirements on this saturated annulus are that one boundary component lie on the splitting surface of the Heegaard splitting and the other wrap around the exceptional fiber. Thus, more generally, i.e., even when M_v does not have exterior boundary:

Lemma 7.2. *Suppose that there is an exceptional fiber f in M_v and an annulus A such that:*

- 1) *One component of ∂A wraps at least twice around f ; and*
- 2) *A is embedded away from $\partial A \cap f$; and*
- 3) *$\partial A \setminus f$ lies in S .*

Then f is a core of either V or W .

Proof: In fact, in the central argument in [21], the existence of a boundary component is used exclusively to produce such an annulus. \square

This more general lemma will be used in the next subsection. A consequence of Lemma 7.1 is that we can make use of the following lemma.

Lemma 7.3. *Suppose that f is an exceptional fiber of M_v and that f is also a core of V . Then $M \setminus \eta(f) = (V \setminus \eta(f)) \cup_S W$ is a Heegaard splitting. Furthermore, $S \cap (M_v \setminus \eta(f))$ is vertical or pseudovertical, respectively, if and only if $S \cap M_v$ is vertical or pseudovertical, respectively. The same holds if f is a core of W .*

Proof: Since f is a core of V , $V \setminus \eta(f)$ is still a compression body. Thus $M \setminus \eta(f) = (V \setminus \eta(f)) \cup_S W$ is a Heegaard splitting. Conversely, if $M \setminus \eta(f) = (V \setminus \eta(f)) \cup_S W$ is a Heegaard splitting, then $(V \setminus \eta(f)) \cup N(f)$ is a compression body. Hence $M = V \cup_S W$ is a Heegaard splitting.

Now by the definition of vertical and pseudovertical, respectively, $S \cap (M_v \setminus \eta(f))$ is vertical or pseudovertical, respectively, if and only if $S \cap M_v$ is vertical or pseudovertical, respectively. Compare Figures 5 and 7. \square

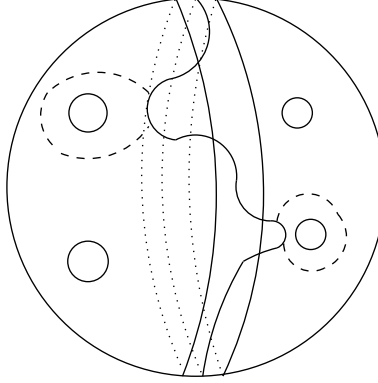

Figure 7: Schematic for vertical Heegaard splittings of graph manifold with boundary

Two cases must be considered, that in which the characteristic submanifold of M is non empty and that in which it is empty, i.e., M is Seifert fibered with non empty boundary.

Proposition 7.4. *Suppose that M is a generalized graph manifold with non empty characteristic submanifold. Suppose that $M = V \cup_S W$ is a Heegaard splitting. Suppose that the active component of $M = V \cup_S W$ is a vertex manifold M_v that is a Seifert fibered space and that has exterior boundary. Then we may isotope the decomposing tori, thereby redefining M_v and the edge manifolds for which e is incident to v slightly, so that after this isotopy, $S \cap M_v$ is a vertical surface and so that an edge manifold becomes the active component.*

Proof: The proof is by induction on the number of exceptional fibers in M_v . Suppose first that M_v contains no exceptional fibers. Denote the exterior boundary of M_v by $\partial_E M_v$. Let \mathcal{A} be a collection of disjoint essential vertical annuli in M_v that cut M_v into a regular neighborhood of $\partial M_v \setminus \partial_E M_v$. After an isotopy, $S \cap \mathcal{A}$ consists of closed curves essential in both S and \mathcal{A} and in the minimal possible number of such curves. In particular, after a small isotopy, this intersection consists of regular fibers of M_v .

Now isotope S so that $S \cap N(\mathcal{A})$ consists of vertical incompressible annuli. Set $\tilde{M}_v = N(\partial_E M_v) \cup N(\mathcal{A})$. Isotope S so that $S \cap \tilde{M}_v$ consists of $S \cap N(\mathcal{A})$ together with annuli in $N(\partial_E M_v) \setminus N(\mathcal{A})$ that join two components of $S \cap N(\mathcal{A})$. Isotope any annuli in $S \cap (M_v \setminus \tilde{M}_v)$ that are parallel into $\partial \tilde{M}_v$ into \tilde{M}_v . Set $\partial_E \tilde{M}_v = \partial_E M_v$.

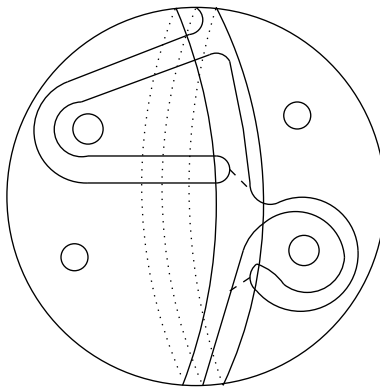

Figure 8: Figure 7 after isotopy

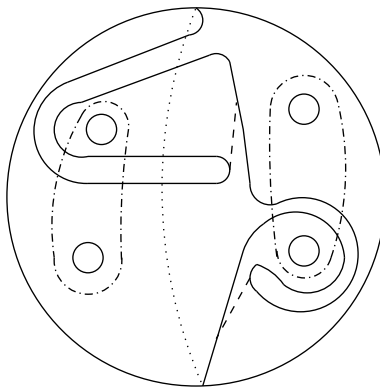

Figure 9: Irregularly dashed arcs indicate new decomposing tori

Let \tilde{T} be a component of $\partial\tilde{M}_v \setminus \partial_E\tilde{M}_v$. Then \tilde{T} is parallel to a decomposing torus or annulus T . We replace T by \tilde{T} . We may do so via an isotopy. We do this for all components of $\partial\tilde{M}_v \setminus \partial_E\tilde{M}_v$. After this process, the conclusions of the proposition hold.

To prove the inductive step, suppose that f is an exceptional fiber of M_v . Then by Lemma 7.1, f is a core of either V or W , say of V . The inductive hypothesis in conjunction with Lemma 7.3 then proves the theorem. \square

For the remaining case, recall the main theorem of [21] stated in the terminology used here.

Theorem 7.5. *Suppose M is a totally orientable Seifert fibered space with non empty boundary. Suppose $M = V \cup_S W$ is a Heegaard splitting. Then S is pseudovertical.*

Proof: This is the main theorem of [21]. \square

7.2 Seifert fibered vertex manifold without exterior boundary

Next we consider the case in which the active component of $M = V \cup_S W$ is a vertex manifold M_v that is a Seifert fibered space and that has no exterior boundary. Part of the strategy is somewhat reminiscent of the strategy used in the preceding case.

However, the situation here is more complicated and a more refined strategy must be used. The refined strategy involves a generalization of Lemma 3.11 to a “spine” of the vertex manifold.

Definition 7.6. *Let Q_v be the base orbifold of M_v . A spine for Q_v is a 1-complex Γ^1 with exactly one vertex v that cuts Q_v into a regular neighborhood of $\partial Q_v \cup$ (exceptional points). A 2-complex of the form $\Gamma^2 = p^{-1}(\Gamma^1)$ is called a spine of M_v . We denote the 1-manifold $p^{-1}(v)$ by γ .*

The following lemma generalizes Lemma 3.11. Though we will only be interested in this lemma in the case that N is a vertex manifold of a graph manifold, we state it in very general terms. It applies to a larger class of 3-manifolds than just graph manifolds.

Lemma 7.7. *Let $M = V \cup_S W$ be a strongly irreducible Heegaard splitting. Let N be a totally orientable Seifert fibered submanifold of M that doesn't meet ∂M . Let Γ^2 be a spine of N . Then S may be isotoped so that the following hold:*

- 1) $S \cap \Gamma^2$ consists of simple closed curves and simple closed curves wedged together at points in γ .
- 2) No closed curve in $S \cap \Gamma^2$ bounds a disk in $\Gamma^2 \setminus S$.

Proof: The first part of the assertion follows by general position. To prove the second assertion, let X be a spine of V and Y a spine of W . Then $M \setminus (\partial_- V \cup X \cup \partial_- W \cup Y)$ is homeomorphic to $S \times (0, 1)$. X can't be disjoint from Γ^2 . Thus for t near 0, $(S \times t) \cap \Gamma^2$ contains simple closed curves that bound essential disks in V . Y can't be disjoint from Γ^2 either. Thus for t near 1, $(S \times t) \cap \Gamma^2$ contains simple closed curves that bound essential disks in W .

As t increases, $(S \times t) \cap \Gamma^2$ changes continuously. Since $M = V \cup_S W$ is strongly irreducible, there can be no t such that $(S \times t) \cap \Gamma^2$ contains simple closed curves that bound essential disks in V and simple closed curves that bound essential disks in W . Thus, there is a t_0 , such that $(S \times t_0) \cap \Gamma^2$ contains no simple closed curves that bound essential disks in V or W . Any remaining disk components in $(S \times t_0) \cap \Gamma^2$ must be inessential in V or W and can hence be removed via isotopy. The lemma follows. \square

Before launching into the two main portions of the argument, we prove an auxiliary lemma. This lemma is a weak version of a counterpart to Theorem 3.3 in [17].

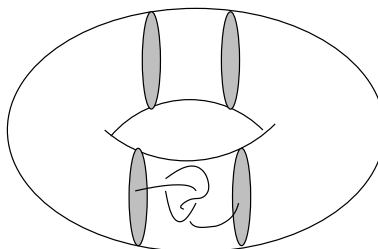

Figure 10: Schematic for a Heegaard splitting intersecting a solid torus

Lemma 7.8. *Suppose $M = V \cup_S W$ is a strongly irreducible Heegaard splitting of a 3-manifold M . Suppose $U \subset M$ is a solid torus such that S intersects ∂U in meridians. Further suppose that $\partial(M \setminus \text{interior}(U))$ is incompressible in $M \setminus \text{interior}(U)$. Then $S \cap U$ consists of meridian disks of U and components that are obtained by ambient 1-surgery on pairs of meridian disks along a single arc that joins the two meridian disks.*

Proof: Let s be a component of $S \cap \partial U$. A collar of s in S is an annulus A . Lemma 2.6 in [19] states: “Suppose S gives a Heegaard splitting of a 3-manifold M into compression bodies V and W . Suppose that $F \subset S$ is a compact subsurface so that every component of ∂F is essential in S . Suppose each component of ∂F bounds a disk in M disjoint from $\text{interior}(F)$. Either ∂F bounds a collection of disks in a single compression body or $M = V \cup_S W$ is weakly reducible.”

Here $M = V \cup_S W$ is strongly irreducible. It follows that either s bounds a disk in S or s bounds a disk in a single compression body, say V . Here $\partial(M \setminus \text{interior}(U))$ is incompressible in $M \setminus \text{interior}(U)$. It follows that in case of the former, s bounds a meridian disk of U in $S \cap U$ and that in case of the latter, a meridian disk of U bounded by s lies entirely in V .

Thus either s bounds a meridian disk in $S \cap U$ or bounds a meridian disk in the surface obtained by compressing $S \cap U$ along D . It follows that $S \cap U$ may be reconstructed from meridian disks by ambient 1-surgery along a collection of arcs such that each meridian disk meets at most one endpoint of one of the arcs. In particular, between two meridian disks there is at most one arc. \square

Lemma 7.9. *Suppose that the active component of $M = V \cup_S W$ is a vertex manifold M_v that is a Seifert fibered space with boundary but no exterior boundary. Then one of the following holds:*

1) *We may isotope the decomposing tori, thereby redefining M_v and the edge manifolds for which e is incident to v slightly, so that after this isotopy, $S \cap M_v$ is either a horizontal or vertical incompressible surface and so that an edge manifold becomes the active component.*

Or:

2) *S may be isotoped within M_v so that a fiber f of M_v lies in S .*

Proof: Let Γ^2 be a spine of M_v and isotope S within M_v so that the conclusions of Lemma 7.7 hold. Three cases need to be considered:

Case 1: A simple closed curve in $S \cap \Gamma^2$ can be isotoped to be vertical.

Then S may be isotoped in M_v so that it contains a regular fiber of M_v .

Case 2: No simple closed curve in $S \cap \Gamma^2$ can be isotoped to be vertical and in each solid torus component U of $M_v \setminus \eta(\Gamma^2)$, $S \cap \partial U$ consists of meridians.

In this case, after a small isotopy, $S \cap N(\Gamma^2)$ is a horizontal incompressible surface. Furthermore, let U be a component of $M_v \setminus \eta(\Gamma^2)$. By Lemma 7.8 $S \cap U$ consists of meridian disks possibly together with other components that are obtained by ambient 1-surgery on pairs of meridian disks along a single arc that joins the two meridian

disks. Isotope each such arc out of U , through $N(\Gamma^2)$, avoiding γ , to lie in a component of $N(\partial M_v)$. Then $S \cap U$ consists of meridians for each solid torus component of $M_v \setminus \Gamma^2$ and all ambient 1-surgeries occur in $N(\partial M_v)$.

Let \tilde{M}_v be the union of $N(\Gamma^2)$ with the solid tori containing the exceptional fibers of M_v . Then \tilde{M}_v is a shrunk version of M_v . Note that $S \cap \tilde{M}_v$ is a horizontal incompressible surface. Let \tilde{T} be a component of $\partial \tilde{M}_v$. Then \tilde{T} is parallel to a decomposing torus T . We replace T by \tilde{T} . We may do so via an isotopy. We do this for all components of $\partial \tilde{M}_v$. After this process, the conclusions of the lemma hold.

Case 3: No simple closed curve in $S \cap \Gamma^2$ can be isotoped to be vertical and there is a solid torus component U of $M_v \setminus \eta(\Gamma^2)$ such that $S \cap \partial U$ does not consist of meridians.

The argument in this case is given, for instance, in Proposition 1.1 of [2]. For completeness we provide a sketch of an argument more in line with the ideas used here. In this case there is a possibly singular annulus A between a component of $S \cap \partial U$ and the exceptional fiber f in U . If A is not singular, then A describes an isotopy of S after which f lies in S . If A is singular, then A satisfies the hypotheses of Lemma 7.2. Thus f is a core of either V or W . I.e., S is the splitting surface for a Heegaard splitting of $M \setminus \eta(f)$. But then Proposition 7.4 applies to $M_v \setminus \eta(f)$ and we may isotope the decomposing tori, thereby redefining M_v and the edge manifolds for which e is incident to v slightly, so that after this isotopy, $S \cap M_v$ is a vertical incompressible surface and so that an edge manifold becomes the active component. \square

Lemma 7.10. *Suppose that the active component of $M = V \cup_S W$ is a vertex manifold M_v that is a Seifert fibered space with boundary but no exterior boundary. Suppose further that a fiber f of M_v lies in S . Then one of the following holds:*

1) *We may isotope the decomposing tori, thereby redefining the active component M_v and the edge manifolds for which e is incident to v slightly, so that after this isotopy, $S \cap M_v$ is a vertical incompressible surface and so that an edge manifold becomes the active component.*

Or:

2) *$S \cap M_v$ is pseudohorizontal.*

Proof: Consider a small regular neighborhood $N(f)$ of f such that $S \cap N(f)$ is a collar A of f . Compress S as much as possible in $M_v \setminus \eta(f)$ to obtain an incompressible surface $S^* \subset M \setminus \eta(f)$. By Haken's Theorem, each compressing disk can be chosen to lie entirely on one side of S . Since $M = V \cup_S W$ is strongly irreducible, all compressions must have been performed to one side of S . It follows that S^* lies either in V or in W . There are three options for $S^* \cap M_v$:

Case 1: $S^* \cap (M_v \setminus \eta(f))$ contains an annulus that is parallel into $\partial N(f)$.

Note that $S \cap N(f)$ is also parallel into $\partial N(f)$. Thus $S \cap M_v = (S^* \cap (M_v \setminus \eta(f))) \cup (S \cap N(f))$ contains a torus bounding a solid torus in either V or W . Furthermore, f lies on the boundary of this solid torus and meets a meridian disk once. After a small isotopy, f is a core of the solid torus. Thus f is a core of either V or W . But then Proposition 7.4 applies to $M_v \setminus \eta(f)$ and we may isotope the decomposing tori, thereby redefining M_v and the edge manifolds for which e is incident to v slightly, so

that after this isotopy, $S \cap M_v$ is vertical and so that an edge manifold becomes the active component.

Case 2: $S^* \cap (M_v \setminus \eta(f))$ is vertical.

If $S^* \cap (M_v \setminus \eta(f))$ is not boundary parallel, then it is essential and can't be contained in V or W . This is a contradiction, hence this case does not occur.

Case 3: $S^* \cap (M_v \setminus \eta(f))$ is horizontal.

Then $(S^* \cap (M_v \setminus \eta(f))) \cup (S \cap N(f))$ is pseudohorizontal, but we must show that in fact $S \cap M_v = (S^* \cap (M_v \setminus \eta(f))) \cup (S \cap N(f))$.

Since ∂A has two components there are two, necessarily parallel, components of $S^* \cap (M_v \setminus \eta(f))$. Moreover, since A is parallel into ∂U in both directions, each component of $M_v \setminus S^*$ is homeomorphic to *(punctured surface)* $\times (0, 1)$.

Suppose now that S^* lies in, say, V . Denote the component of $M \setminus S^*$ that meets W by \hat{W} . Then S defines a Heegaard splitting of \hat{W} . Let \mathcal{D} be a set of disks in the interior of M_v that cut $\hat{W} \cap M_v$ into a collar of the annuli $\hat{W} \cap \partial M_v$. By Haken's Theorem, each such disk can be isotoped to intersect S in a single circle. We may assume that after this isotopy, \mathcal{D} still lies in the interior of M_v .

Here S may be reconstructed by performing ambient 1-surgery on S^* along arcs in \hat{W} . But this collection of arcs is disjoint from \mathcal{D} . Thus all such arcs may be isotoped into edge manifolds M_e such that e is incident to v . Note that an edge manifold that contains such an arc becomes the active component. Also note that after this isotopy, the portion of S remaining in M_v is pseudohorizontal.

If a surface is pseudohorizontal, then it is boundary compressible. In particular, it lives in the active component. Hence the existence of such arcs contradicts Lemma 6.1. Thus $S \cap M_v = (S^* \cap (M_v \setminus \eta(f))) \cup (S \cap N(f))$. \square

7.3 Vertex manifold not Seifert fibered

Next we consider the case in which the active component of $M = V \cup_S W$ is a vertex manifold M_v that is homeomorphic to *(compact orientable surface)* $\times I$. The strategy here is an adaptation of the argument in the preceding case. Though the setup here is much simpler.

Definition 7.11. *Let Q be a compact surface with non empty boundary. A spine of Q is a 1-complex Γ^1 with exactly one vertex v that cuts Q into a regular neighborhood of ∂Q . A 2-complex of the form $\Gamma^2 = \Gamma^1 \times I$ is called a spine of $Q \times I$. We denote the 1-manifold $v \times I$ by γ .*

The following lemma is another generalization of Lemma 3.11. We will only be interested in this lemma in the case that N is a vertex manifold of a graph manifold, but again we state it in very general terms. It too applies to a larger class of 3-manifolds than just generalized graph manifolds.

Lemma 7.12. *Let $M = V \cup_S W$ be a strongly irreducible Heegaard splitting. Suppose N is a submanifold of M homeomorphic to *(compact surface)* $\times I$ such that *(compact surface)* $\times \partial I \subset \partial M$. Let Γ^2 be a spine of N . Then S may be isotoped so that the following hold:*

1) $S \cap \Gamma^2$ consists of simple closed curves and simple closed curves wedged together at points in γ .

2) No closed curve in $S \cap \Gamma^2$ bounds a disk in $\Gamma^2 \setminus S$.

The proof of this lemma is identical to the proof of Lemma 7.7.

Lemma 7.13. *Suppose that the active component of $M = V \cup_S W$ is a vertex manifold M_v that is homeomorphic to (compact orientable surface) $\times I$. Then we may isotope the decomposing annuli, thereby redefining the active component M_v and the edge manifolds for which e is incident to v slightly, so that after this isotopy, $S \cap M_v$ is a horizontal incompressible surface and so that an edge manifold becomes the active component.*

Proof: Let Γ^2 be a spine of M_v and isotope S within M_v so that the conclusions of Lemma 7.12 hold. Then $S \cap \Gamma^2$ consists of horizontal curves. Here $S \cap N(\Gamma^2)$ is a bicollar of $S \cap \Gamma^2$ and hence a horizontal incompressible surface.

Let \tilde{M}_v be $N(\Gamma^2)$. Let \tilde{A} be a component of $\partial\tilde{M}_v \setminus \partial M_v$. Then \tilde{A} is parallel to a decomposing annulus A . We replace A by \tilde{A} . We may do so via an isotopy. We do this for all components of $\partial\tilde{M}_v \setminus \partial M_v$. After this process, the conclusions of the lemma hold. \square

7.4 Edge manifold homeomorphic to (annulus) $\times I$

Now we consider the case in which the active component of $M = V \cup_S W$ is an edge manifold M_e homeomorphic to (annulus) $\times I$. This case turns out to be a direct application of the following theorem of Marty Scharlemann:

Theorem 7.14. *Suppose $M = V \cup_S W$ is a strongly irreducible Heegaard splitting and $U \subset M$ is a solid torus such that S intersects ∂U in parallel essential non meridional curves. Then S intersects U in a collection of boundary parallel annuli and possibly one other component, obtained from one or two annuli by ambient 1-surgery along an arc parallel to a subarc of ∂U . If the latter sort of component is in U , then $S \setminus U$ is incompressible in $M \setminus U$.*

Proof: This is Theorem 3.3 in [17]. \square

The following proposition is stated in general terms. Our interest in this theorem will be the case in which $A \times I$ is an edge manifold. Since $A \times I$ is a solid torus, this proposition follows directly from Scharlemann's Theorem (Theorem 7.14).

Proposition 7.15. *Suppose $A \times I$ is an imbedding of (annulus) $\times I$ in the interior of M with $A \times \{\text{point}\}$ essential in M . Further suppose that $M = V \cup_S W$ is a strongly irreducible Heegaard splitting. If both components of $S \cap (A \times \partial I)$ consist of curves essential in both S and $(A \times \partial I)$, then $S \cap (A \times I)$ is isotopic to a collection of incompressible annuli and possibly one other component, obtained from two annuli by ambient 1-surgery along an arc parallel to a subarc of $A \times \{\text{point}\}$.*

The following definition clarifies the statement of Proposition 7.15.

Definition 7.16. Let A be an annulus and let $N = A \times I$. A spanning annulus for N is an annulus of the form $c \times I$, for c an essential curve in A . Similarly, let T be a torus and $N = T \times I$. A spanning annulus for N is an annulus of the form $c \times I$, for c an essential curve in T .

Each of the incompressible annuli mentioned in Proposition 7.15 is either a spanning annulus or is parallel into $A \times \partial I$. In Figure 11 we see two isotopic possibilities. Note that the tube we see on the left hand side is actually “dual” to the tube we see on the right hand side.

The tube on the left hand side could (after straightening out the picture) be seen as ambient 1-surgery along an arc parallel to a subarc of $\{point\} \times I$ (a vertical arc). In this case the the tube on the right hand side would be seen as ambient 1-surgery along an arc parallel to a subarc of $A \times \{point\}$ (a horizontal arc).

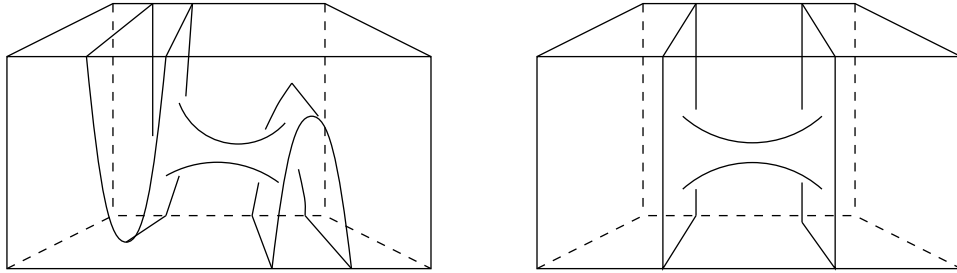

Figure 11: Two isotopic possibilities

7.5 Edge manifold homeomorphic to $(torus) \times I$

Next we consider the case in which the active component of $M = V \cup_S W$ is an edge manifold M_e homeomorphic to $(torus) \times I$. The theorem proven here applies in very general contexts. The techniques used are those developed by Rubinstein and Scharlemann in [16].

The use of these techniques is inspired by Cooper and Scharlemann’s application of the central argument in [16] to the setting of Heegaard splittings of solvmanifolds in [6, Theorem 4.2]. The arguments in this section are identical to the argument in [6, Theorem 4.2]. We weaken one of the hypotheses slightly. In addition, in the setting here, there are no constraints on $S \cap (T \times \partial I)$. In [6] a constraint arises due to the fact that in a solvmanifold the two components of $T \times \partial I$ are identified. This means that some scenarios that arise in the argument for [6, Theorem 4.2] can be ruled out there. But they can’t be ruled out here. Thus our conclusions are slightly different.

The argument is rather lengthy. The reader is referred to [6] for a sketch and to [16] for details.

We recall some fundamentals concerning the Rubinstein-Scharlemann graphic. Let Σ_V be a spine of V and Σ_W a spine of W . Then $M \setminus (\partial_- V \cup \Sigma_V \cup \partial_- W \cup \Sigma_W)$ is homeomorphic to $S \times I$. This product foliation is called a sweepout. If S intersects a product submanifold $N = Q \times I$ of M then to each point (s, t) in $I \times I$ we may associate $S_s = S \times \{s\}$ and $Q_t = Q \times \{t\}$. We are interested in $S_s \cap Q_t$.

After a small isotopy, we may assume that the spines and the sweepout are in general position with respect to the foliation of $Q \times I$. There is then a 1-dimensional complex Γ in $I \times I$ called the Rubinstein-Scharlemann graphic. See Figure 12. At a point (s, t) away from Γ , S_s and Q_t are in general position. On an edge of Γ the surfaces S_s and Q_t have a single point of tangency. At a vertex of Γ there are either two points of tangency or a “birth-death” singularity.

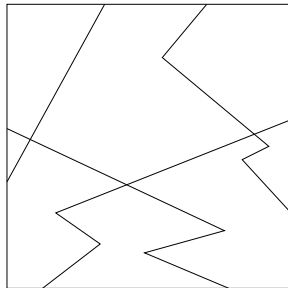

Figure 12: *The Rubinstein-Scharlemann graphic*

For (s, t) in a region of $(I \times I) \setminus \Gamma$, $S_s \cap Q_t$ is topologically rigid. If there is a curve c in $S_s \cap Q_t$ that is essential in S_s but bounds a disk in Q_t that lies in V near c , then we label the region V . Similarly, if there is a curve c' in $S_s \cap Q_t$ that is essential in S_s but bounds a disk in Q_t that lies in W near c , then we label the region W .

We summarize some of the insights from [16]:

Remark 7.17. *If a region R is labelled V , then for $(s, t) \in R$ the curve c in $S_s \cap Q_t$ that is essential in S_s and bounds a disk in Q_t that lies in V near c also bounds a disk that lies entirely in V . The equivalent statement holds for the label W . (This is [16, Lemma 4.3].)*

This fact has the following immediate consequences.

Remark 7.18. *If a region is labelled both V and W , then $M = V \cup_S W$ is weakly reducible. (This is [16, Corollary 4.4].)*

Remark 7.19. *If for some $s \in (0, 1)$ and some $t_0, t_1 \in (0, 1)$ there is a region labelled V containing (s_0, t_0) and a region labelled W containing (s_0, t_1) , then $M = V \cup_S W$ is weakly reducible.*

Remark 7.19 is not explicitly stated in [16] but follows immediately from the definitions and Remark 7.17. Indeed, the labelling in the region containing (s_0, t_0) gives an essential disk to one side of S_{s_0} and the labelling in the region containing (s_0, t_1) gives an essential disk to the other side of S_{s_0} . The boundaries of these disks are contained in Q_{t_0} and Q_{t_1} respectively. As Q_{t_0} and Q_{t_1} are disjoint, the boundaries of these disks are disjoint. Hence $M = V \cup_S W$ is weakly reducible.

More subtle facts are the following:

Remark 7.20. *The labels V and W cannot both appear in regions adjacent along an edge. (This is [16, Corollary 5.5].)*

Notice that for small s , $S_s \cap (Q \times I)$ is the boundary of a small regular neighborhood of $\Sigma_V \cap (Q \times I)$. If the leaves of the foliation of $Q \times I$ are essential, then Σ_V can't miss any such leaf. Similarly for Σ_W . Thus we have the following:

Remark 7.21. *If the leaves of the foliation of $Q \times I$ are essential in M , then every region of $(I \times I) \setminus \Gamma$ abutting the left edge of $I \times I$ is labelled V . Every region of $(I \times I) \setminus \Gamma$ abutting the right edge of $I \times I$ is labelled W .*

As a warm up in the application of these principles, we prove the following lemma:

Lemma 7.22. *Suppose that $N = Q \times I$ is a product submanifold of M . Suppose further that $M = V \cup_S W$ is a strongly irreducible Heegaard splitting. Let Γ be the Rubinstein-Scharlemann graphic and suppose there is a vertex (s_0, t_0) of Γ with the following properties:*

- 1) *Four regions meet at (s_0, t_0) .*
- 2) *One region is labelled V and one region is labelled W .*

Then the following hold:

- A) *The other two regions abutting (s_0, t_0) are unlabelled.*
- B) *The regions labelled V and W lie opposite each other.*
- C) *The graph $G = S_{s_0} \cap Q_{t_0}$ in Q_{t_0} contains a connected subgraph \tilde{G} with two vertices v_1, v_2 , each of valence 4.*
- D) *If an edge e of G has both ends on the same vertex v then $e \cup v$ is an essential circle in Q_{t_0} .*
- E) *\tilde{G} is not contractible in Q_{t_0} .*

Proof: Observations A and B follow directly from Remark 7.20. Recall that each edge signifies a tangency between S_{s_0} and Q_{t_0} . If the tangency corresponds to a maximum or minimum, then the labelling of adjacent regions does not change as the edge is traversed. So here the tangencies corresponding to edges must arise from saddle singularities.

It follows that $S_{s_0} \cap Q_{t_0}$ consists of a graph G in Q_{t_0} that has two valence four vertices. In the four regions abutting (s_0, t_0) the valence four vertices break apart in four possible combinations. See Figure 13.

Suppose the two valence four vertices of G lie on distinct components \tilde{G}_1, \tilde{G}_2 of G . As \tilde{G}_1, \tilde{G}_2 break apart as in Figure 13, the curves arising from \tilde{G}_1 remain disjoint from the curves arising from \tilde{G}_2 . Furthermore, the curves arising from \tilde{G}_1 are identical in the regions North and East and in the regions West and South. The curves arising from \tilde{G}_2 are identical in the regions North and West and in the regions East and South. It follows that one of the components, say \tilde{G}_1 , must give rise to the labelling V and the other component, say \tilde{G}_2 , must give rise to the labelling W . But then two adjacent regions, say the regions North and East, are labelled V . A contradiction. Thus C holds.

Denote the vertices by v_1 and v_2 . Suppose that e has both ends on v_1 and that $v_1 \cup e$ is inessential. Then there will be two adjacent regions, say the regions North

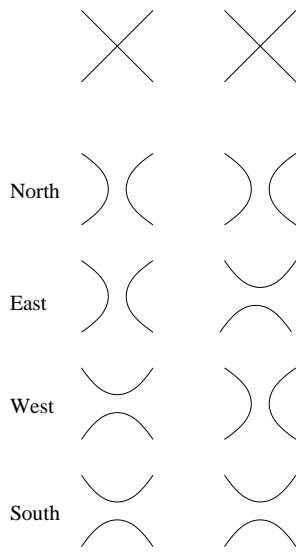

Figure 13: *How S_s meets T_t in the four regions North, East, West and South meeting (s_0, t_0)*

and East, in which this monogon gives rise to a simple closed curve. Since one of the regions, say North, is labelled, say V , this simple closed curve must give rise to a labelling V . But then it gives rise to this labelling in both the region North and in the region East. A contradiction. Hence D holds.

Finally, suppose \tilde{G} is contractible in Q_{t_0} . By D, each edge has endpoints on distinct vertices. Thus \tilde{G} is as in Figure 14. Hence in the regions North, East, West and South of $(I \times I) \setminus \Gamma$ we see components of intersection of $S_s \cap Q_t$ in Q_t as in Figure 15.

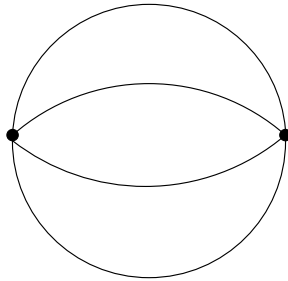

Figure 14: *\tilde{G} is contractible*

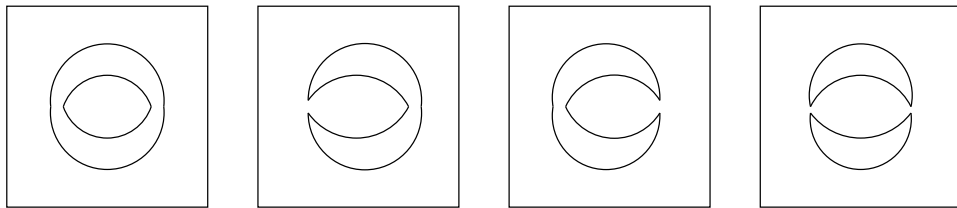

Figure 15: *The regions North, East, West and South*

The curves of intersection pictured are the ones giving rise to the labellings. Note that if the circles pictured in East and West give rise to labellings, then they give rise

to the same labelling. Hence these regions must both be unlabelled. It follows that North and South are the labelled regions. If the larger circle pictured in North gives rise to a labelling, then this labelling coincides with the labelling arising from the circle(s) pictured in South. But this is impossible. Thus the smaller circle pictured in North gives rise to the labelling. We may assume that it gives rise to the label V .

Let $(s, t) \in \text{North}$. Denote the annulus cut out by the two circles in North by \tilde{A} . Denote the disk cut out by the inner circle by \tilde{D} . By Remark 7.17 we may assume that $\tilde{D} \subset V$. Denote the outer component of $\partial\tilde{A}$ by c and the inner component by c' . Since c' gives rise to a labelling, c' is essential in S_s . Since c does not give rise to a labelling, c is inessential in S_s . Let $D \subset S_s$ be the disk bounded by c . We may assume that this disk is disjoint from $c \cup c'$. After a small isotopy, $\tilde{A} \cup D$ is an essential disk in W . But here $\partial(\tilde{A} \cup D) = \partial\tilde{D}$. So $M = V \cup_S W$ is reducible. But this is impossible. Thus \tilde{G} is not contractible in Q_{t_0} . Hence E holds. \square

The following proposition gives the required information concerning the intersection of a strongly irreducible Heegaard splitting with an edge manifold homeomorphic to $(\text{torus}) \times I$ when this edge manifold is the active component.

Proposition 7.23. *Suppose $T \times I$ is an imbedding of $(\text{torus}) \times I$ in the interior of M with $T \times \{t\}$ essential in M . Further suppose that $M = V \cup_S W$ is a strongly irreducible Heegaard splitting. If $S \cap (T \times \partial I)$ consist of curves essential in both S and $(T \times \partial I)$, then $S \cap (T \times I)$ is characterized by one of the following:*

1) $S \cap (T \times I)$ is isotopic to a collection of incompressible annuli and possibly one other component, obtained from two such annuli by ambient 1-surgery along an arc parallel to a subarc of $T \times \{\text{point}\}$.

2) There is a pair of simple closed curves $c, c' \subset T$ such that $c \cap c'$ consists of a single point $p \in T$ and $V \cap (T \times I)$ is a collar of $(c \times \{0\}) \cup (p \times I) \cup (c' \times \{1\})$.

Proof: Consider the regions of $(I \times I) \setminus \Gamma$ abutting $I \times \{0\}$. Since $S \cap (T \times \partial I)$ consist of curves essential in both S and $(T \times \partial I)$ there must be an unlabelled such region. We call this region R_0 . Similarly, there must be an unlabelled region, which we call R_1 , that abuts $I \times \{1\}$. Because of the conditions on $S \cap (T \times \partial I)$ we may assume that for (s, t) in R_0 or R_1 , $S_s \cap T_t$ consists of curves essential in both S_s and T_t . We are interested in monotone paths from R_0 to R_1 .

Our argument breaks into two cases: Either there is a path in $I \times I$ from R_0 to R_1 that avoids labelled regions or there is no such path.

Case 1: There is a path beginning in R_0 and ending in R_1 that traverses only unlabelled regions and edges between such regions. See Figure 16.

It follows from Remark 7.19 that there is a monotone path α beginning in R_0 and ending in R_1 that traverses only unlabelled regions and edges between such regions.

Consider the effect of traversing an edge e from one unlabelled region of $(I \times I) \setminus \Gamma$ to another. Since compression bodies do not contain essential surfaces, $S_s \cap T_t$ must contain curves essential in S_s . For (s, t) in an unlabelled region, such curves must also be essential in T_t . We may thus refer to curves inessential in both S_s and T_t simply as inessential and to curves essential in both S_s and T_t simply as essential.

If an essential curve is banded to itself, then either one essential curve or one inessential and one essential curve result. But the first possibility can't occur here, because here $S \cap T_t$ is separating for all t . Thus one inessential and one essential curve result. The inessential curve bounds a disk in S . Hence the appearance of the new inessential curve merely indicates a saddle singularity, with respect to projection onto t , in the imbedding of an essential annulus. Thus we may again ignore this phenomenon.

Finally, suppose that a pair of essential curves disappears as two essential curves are banded to each other to produce an inessential curve. The inessential curve bounds a disk in S . Thus the components of $S \cap T_t$ affected piece together to form an annulus that is parallel into $T_{t_0-\epsilon}$.

Since there are no inessential curves for $t = 0$ or $t = 1$, we see that, after further isotopies, $S \cap (T \times I)$ consists of spanning annuli and annuli parallel into $T \times \partial I$.

Case 2: There is no path beginning in R_0 and ending in R_1 that traverses only unlabelled regions and edges between such regions. See Figure 17.

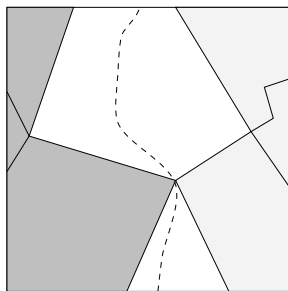

Figure 17: A monotone path through unlabelled regions

In this case the regions of $(I \times I) \setminus \Gamma$ labelled V extending from the left edge of $I \times I$ must meet the regions of $(I \times I) \setminus \Gamma$ labelled W extending from the right edge of $I \times I$. By Remark 7.20 this can only happen at a vertex. Thus Lemma 7.22 applies.

We consider \tilde{G} as in C) of Lemma 7.22. Denote the vertices by v_1, v_2 and the edges by e_1, e_2, e_3, e_4 . Suppose first that one edge, say e_1 has both ends on v_1 . Then since \tilde{G} is connected, and since v_1 and v_2 have valence four, there must be exactly two edges e_2, e_3 , each with one end on v_1 and one end on v_2 . It follows that e_4 must have both ends on v_2 . By Lemma 7.22 both $v_1 \cup e_1$ and $v_2 \cup e_4$ are essential. Since these curves lie on a torus, they are parallel. The other possibility is that all edges have one end on v_1 and one end on v_2 .

Subcase 2.1: e_1 has both ends on v_1 , e_4 has both ends on v_2 and e_2 and e_3 are parallel.

Here \tilde{G} is as in Figure 18:

This implies that as v_0 is crossed going from one unlabelled region to another, $S \cap T_t$ changes as in Figure 19:

But this corresponds to the addition of a 1-handle. The core of the 1-handle can be isotoped into T_{t_0} . Since there are essential disks for both V and W cut out by \tilde{G} , $S \setminus (T \times [t_0 - \epsilon, t_0 + \epsilon])$ is incompressible in $M \setminus (T \times [t_0 - \epsilon, t_0 + \epsilon])$. In particular, we may assume that $S \cap (T \times \{t_0 - \epsilon, t_0 + \epsilon\})$ consists of curves essential in S and in $T_{t_0 \pm \epsilon}$. This implies that $S \cap (T \times [t_0 - \epsilon, t_0 + \epsilon])$ is as described in option 1).

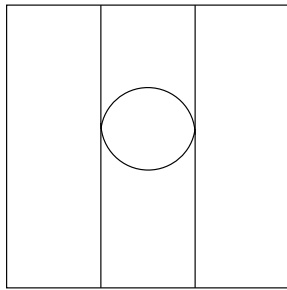

Figure 18: \tilde{G} contains a bigon

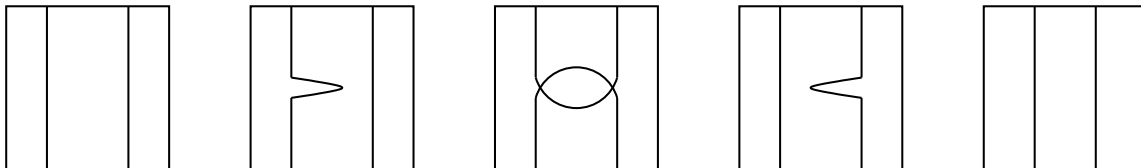

Figure 19: Adding a 1-handle

To see that option 1) holds for all of $S \cap (T \times I)$, note that $S \cap ((T \times I) \setminus (T \times [t_0 - \epsilon, t_0 + \epsilon]))$ consists of incompressible annuli. Spanning annuli merely extend components of $S \cap (T \times [t_0 - \epsilon, t_0 + \epsilon])$. Annuli parallel into $T_{t_0 \pm \epsilon}$ create annuli parallel into $T \times \partial I$ unless they meet the compressible component of $S \cap (T \times [t_0 - \epsilon, t_0 + \epsilon])$.

The question is thus merely whether the ends of the compressible component of $S \cap (T \times [t_0 - \epsilon, t_0 + \epsilon])$ meet spanning annuli or annuli parallel into $T_{t_0 \pm \epsilon}$. There are a number of possibilities. But all possibilities are either as described in option 1) or lead to a contradiction, by implying that S is stabilized. Some options are pictured in in Figure 20, Figure 21, Figure 22.

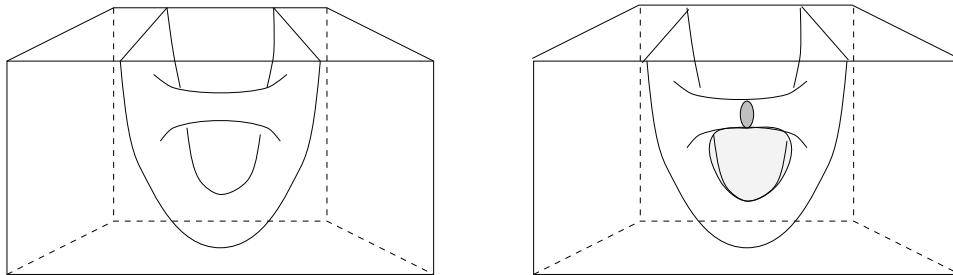

Figure 20: Compressible component meets annulus parallel into $T_{t_0 \pm \epsilon}$

Subcase 2.2: e_1 has both ends on v_1 , e_4 has both ends on v_4 and e_2 and e_3 are not parallel.

Here \tilde{G} is as in Figure 23.

This implies that as v_0 is crossed going from one unlabelled region to another, $S \cap T_t$ changes as in Figure 24:

Thus $S \cap T \times [t_0 - \epsilon, t_0 + \epsilon]$ consists of spanning annuli together with one component that is obtained as follows: an annulus that is parallel into $T_{t_0 \pm \epsilon}$ is tubed to a spanning annulus. This is precisely the type of compressible component that arises in Case 2.1 if an annulus parallel into $T_{t_0 - \epsilon}$ is attached to one end of the compressible component

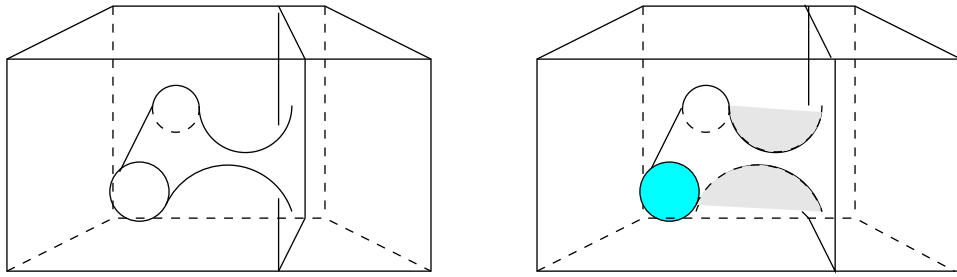

Figure 21: Another stabilized possibility

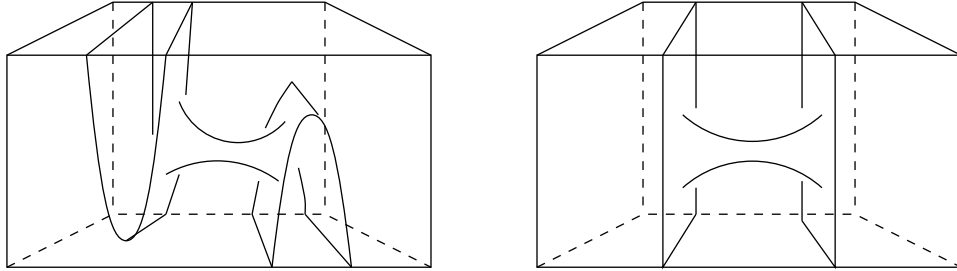

Figure 22: Two isotopic possibilities

and one end of a spanning annulus. Thus as in Case 2.1, all unstabilized configurations involving $S \cap T \times [t_0 - \epsilon, t_0 + \epsilon]$ are as described in option 1).

Subcase 2.3: All edges have one end on v_1 and the other on v_2 .

Note that S is separating. This induces a bicoloring of $T_{t_0} \setminus S$. Such a bicoloring is not possible if two edges are parallel. This forces \tilde{G} to be as in Figure 25:

This implies that as v_0 is crossed going from one unlabelled region to another, $S \cap T_t$ changes as in Figure 26:

In particular, $S \cap T \times [t_0 - \epsilon, t_0 + \epsilon]$ is as in option 2). Again, $S \cap ((T \times I) \setminus (T \times [t_0 - \epsilon, t_0 + \epsilon]))$ consists of incompressible annuli. If an end of $S \cap T \times [t_0 - \epsilon, t_0 + \epsilon]$ meets an annulus that is not isotopic to a spanning annulus, then both ends meet this annulus. But this would imply that $S \cap (T \times I)$ is disconnected. Hence the ends of $S \cap T \times [t_0 - \epsilon, t_0 + \epsilon]$ meet spanning annuli and $S \cap (T \times I)$ is as in option 2). See Figure 26. \square

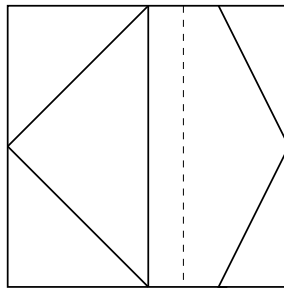

Figure 23: \tilde{G} contains a triangle (dashed arc included along with \tilde{G} to indicate that a bicoloring, as required, is possible)

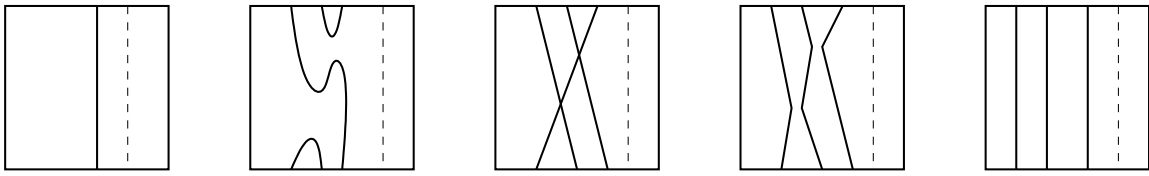

Figure 24: Adding an “essential” 1-handle

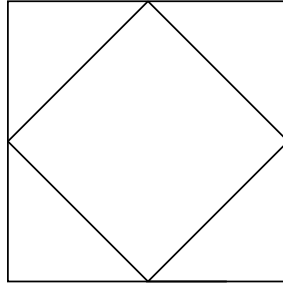

Figure 25: \tilde{G} contains a square

8 Fitting the pieces together

We here prove the main theorem. As it turns out, the hard work is already done. It remains to fit the results together.

In the following, we will assume that the characteristic submanifolds of our graph manifolds and generalized graph manifolds are non empty. Graph manifolds with empty characteristic submanifolds are Seifert fibered spaces. The corresponding result for Seifert fibered spaces was obtained by Y. Moriah and the author in [13] together with [21] and [22]. Generalized graph manifolds with empty characteristic submanifolds are either Seifert fibered spaces or product manifolds of the form $(surface) \times I$. The corresponding result for such manifolds was obtained by M. Scharlemann and A. Thomspson in [19].

Theorem 8.1. *Suppose M is a totally orientable generalized graph manifold. If $M = V \cup_S W$ is a strongly irreducible Heegaard splitting, then $M = V \cup_S W$ is standard.*

More specifically, let \mathcal{E} be the characteristic submanifold of M . Then S can be isotoped so that for each vertex manifold M_v of M , $S \cap M_v$ is either horizontal, pseudohorizontal, vertical or pseudovertical and such that for each edge manifold $M_e = (annulus) \times I$, or $M_e = (torus) \times I$ respectively, $S \cap M_e$ is characterized by one of the following:

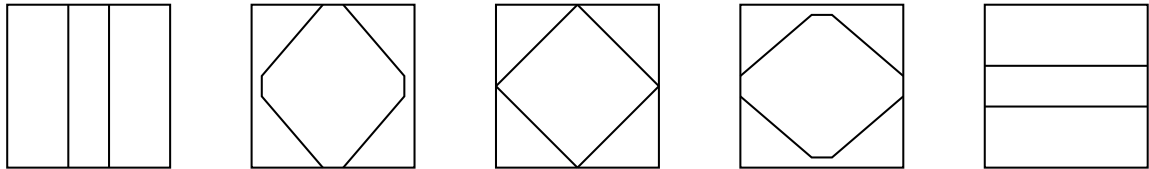

Figure 26: Another way of adding a 1-handle

1) After isotopy, $S \cap M_e$ is obtained from a collection of incompressible annuli by ambient 1-surgery along arcs each of which is parallel into $(\text{annulus}) \times \{\text{point}\}$, or $(\text{torus}) \times \{\text{point}\}$, respectively.

2) $M_e = (\text{torus}) \times I$ and there is a pair of simple closed curves $c, c' \subset (\text{torus})$ such that $c \cap c'$ consists of a single point $p \in (\text{torus})$ and $V \cap ((\text{torus}) \times I)$ is a collar of $(c \times \{0\}) \cup (p \times I) \cup (c' \times \{1\})$.

Proof: If $\mathcal{E} = \emptyset$, then S is either pseudohorizontal or pseudovertical, by the main theorems of [19], [13], [21] and [22]. Thus we may assume in what follows that $\mathcal{E} \neq \emptyset$.

Let \mathcal{T} be the collection of decomposing annuli and tori. Let N be a component of $M \setminus \mathcal{T}$. By Lemma 6.1, $S \cap N$ is incompressible unless N is the active component. Thus if N is not the active component, then $S \cap N$ is as required. Specifically, if N is a vertex manifold, $S \cap N$ is either horizontal or vertical. And if N is an edge manifold, then $S \cap N$ consists of incompressible annuli.

If N is the active component, we must consider the possibilities: If N is a vertex manifold that is Seifert fibered and has non empty external boundary then Proposition 7.4 applies. If N is a vertex manifold that is a product, then Lemma 7.13 applies. Thus in these two cases, we may rechoose the decomposing annuli or tori so that an edge manifold becomes the active component. Similarly, if N is vertex manifold that is a Seifert fibered space with no external boundary, then either $S \cap N$ is pseudohorizontal, or we may rechoose the decomposing tori so that an edge manifold becomes the active component.

Finally, if N is an edge manifold, then $S \cap N$ is as required by Proposition 7.15 and Proposition 7.23. \square

Now the main theorem follows from Theorem 8.1 along with the constructions of untelescoping and amalgamation. Recall Theorem 3.10 which states that, given an irreducible Heegaard splitting, the amalgamation of the weak reduction of this Heegaard splitting yields the original Heegaard splitting. To prove the main theorem, we must hence merely consider the result of amalgamating strongly irreducible Heegaard splittings of generalized graph manifolds. Thereby, we reconstruct all possible Heegaard splittings of a graph manifold.

Proof: (of Theorem 1.1) If $\mathcal{E} = \emptyset$, then S is either pseudohorizontal or pseudovertical, by the main theorems of [13], [21] and [22]. Thus we may assume in what follows that $\mathcal{E} \neq \emptyset$.

Consider the irreducible Heegaard splitting $M = V \cup_S W$. Let $M = (V_1 \cup_{S_1} W_1) \cup_{F_1} \cdots \cup_{F_{n-1}} (V_n \cup_{S_n} W_n)$ be a weak reduction of $M = V \cup_S W$. Denote the decomposing tori by \mathcal{T} . By Lemma 4.2, $\cup_i F_i$ can be isotoped, so that for each vertex manifold M_v of M , $F_i \cap M_v$ is either horizontal or vertical and so that for each edge manifold M_e , $F_i \cap M_e$ is incompressible. If we assume that the number of components of intersection of $\cup_i F_i$ with the decomposing tori is minimal, then $\cup_i F_i$ intersects an edge manifold $(\text{torus}) \times I$ either in annuli of the form $(\text{essential curves}) \times I$ or in tori of the form $(\text{torus}) \times \{\text{point}\}$.

Consider the result of cutting M along $\cup_i F_i$. When we cut along a component of $\cup_i F_i$ of the form $(\text{torus}) \times \{\text{point}\}$ in an edge manifold we obtain a collar on a boundary component of an adjacent Seifert fibered vertex manifold. Recall that we

may ignore this collar by choosing a foliation of this collar by circles that is compatible with the fibration of the Seifert fibered vertex manifold.

Thus a 3-manifold $M_i = V_i \cup_{S_i} W_i$ cut out from M by $F_{i-1} \cup F_i$ is a totally orientable generalized graph manifold. Furthermore, $M_i = V_i \cup_{S_i} W_i$ is a strongly irreducible Heegaard splitting of this totally orientable generalized graph manifold. By Theorem 8.1, $M_i = V_i \cup_{S_i} W_i$ is standard.

Let N_v be a vertex manifold of M . We consider the result of the amalgamation of the standard Heegaard splittings of the M_i while restricting our attention to N_v . There are two possibilities:

Case 1) For each i , $M_i \cap N_v$ is either empty or a Seifert fibered space.

Suppose first that here $N_v \subset M_{i_0}$ for some i_0 . Then N_v is a vertex manifold of M_{i_0} . Thus by Theorem 8.1, $S_{i_0} \cap N_v$ is horizontal, pseudohorizontal, vertical or pseudovertical. Since $N_v \subset M_{i_0}$, $S \cap N_v = S_{i_0} \cap N_v$, i.e., $S \cap N_v$ is unaffected by the process of amalgamation. Thus $S \cap N_v$ is horizontal, pseudohorizontal or vertical.

If it is not the case that $N_v \subset M_{i_0}$ for some i_0 , then set $N_v^i = M_i \cap N_v$ and observe that N_v^i is a vertex manifold of M_i with non empty exterior boundary. Thus, by Proposition 7.4 and Theorem 7.5, for all i , $S_i \cap N_v^i$ is vertical or pseudovertical.

During amalgamation of Heegaard splittings, vertical surfaces are either unaffected or identified. But they remain vertical, see Figure 27.

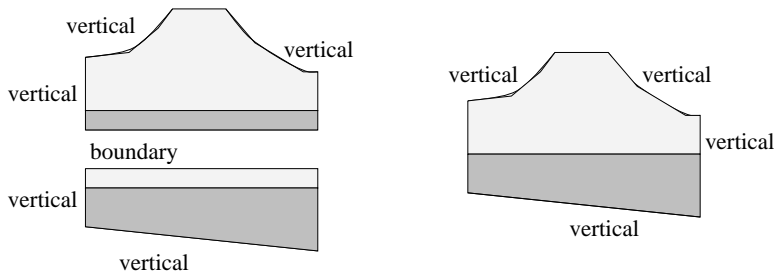

Figure 27: Local picture of amalgamation of vertical Heegaard splittings

To consider what happens to pseudovertical surfaces, recall that a pseudovertical surface is obtained by performing ambient 1-surgery on vertical surfaces along arcs with certain properties. Hence the result of amalgamating pseudovertical surfaces can be obtained by first amalgamating the vertical surfaces and then performing the ambient 1-surgeries. One must merely ensure that the endpoints of the arcs along which the ambient 1-surgeries are to take place do not coincide. See Figure 28.

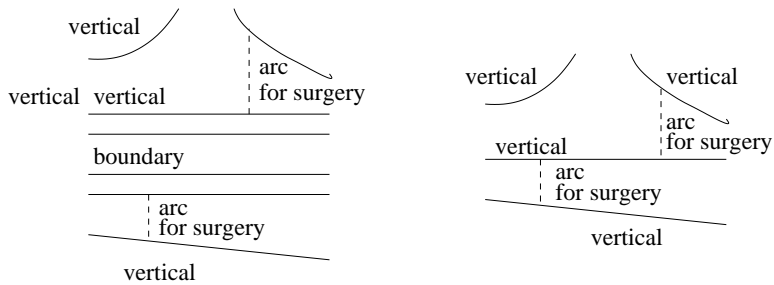

Figure 28: Local picture of amalgamation of pseudovertical Heegaard splittings

Thus $S \cap N_v$ is vertical or pseudovertical.

Case 2) For each i , $M_i \cap N_v$ is either empty or homeomorphic to $(compact\ surface) \times I$.

Again, set $N_v^i = M_i \cap N_v$. By Lemma 7.13, $S \cap N_v^i$ is horizontal for all i . During amalgamation of Heegaard splittings, horizontal surfaces are either unaffected or identified. But they remain horizontal. Thus $S \cap N_v$ is horizontal. See Figure 29.

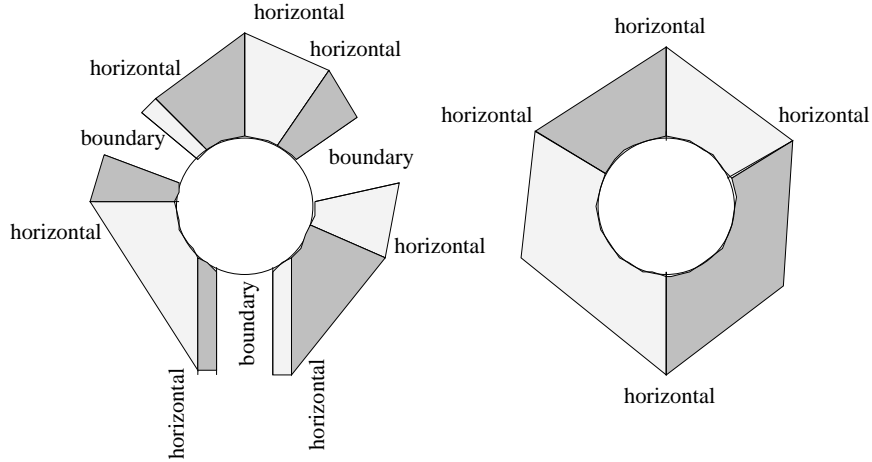

Figure 29: Local picture of amalgamation of horizontal Heegaard splittings

Let N_e be an edge manifold of M . We consider the result of the amalgamation of the standard Heegaard splittings of the M_i while restricting our attention to N_e .

If $N_e \subset M_{i_0}$ for some i_0 , then $S \cap N_e = S_{i_0} \cap N_e$. Here $S_{i_0} \cap N_e$ is as required. Thus $S \cap N_e$ is as required.

Suppose it is not the case that $N_e \subset M_{i_0}$ for some i_0 . Again, set $N_e^i = M_i \cap N_e$. There are two cases:

Case 1) Each N_e^i is either empty or is an edge manifold of M_i homeomorphic to $(annulus) \times I$.

In this case, by Proposition 7.15, for all i , $S_i \cap N_e^i$ is isotopic to a collection of incompressible annuli and possibly one other component, obtained from two such annuli by ambient 1-surgery along an arc parallel to a subarc of $A \times \{point\}$. The amalgamation of Heegaard splittings creates a surface in N_e that is obtained from a collection of incompressible annuli by ambient 1-surgery along arcs each of which is parallel to a subarc of $(torus) \times \{point\}$. See Figure 30 and Figure 31. Thus $S \cap N_e$ is as required.

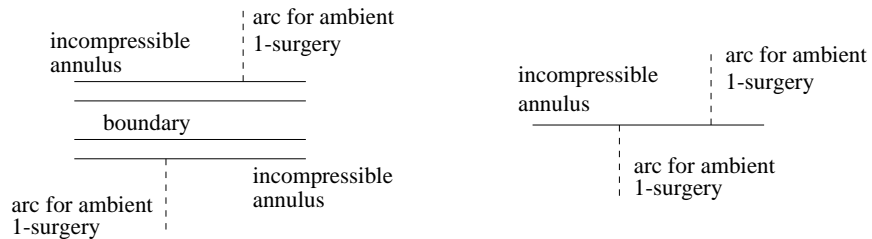

Figure 30: Local picture of amalgamation of Heegaard splittings

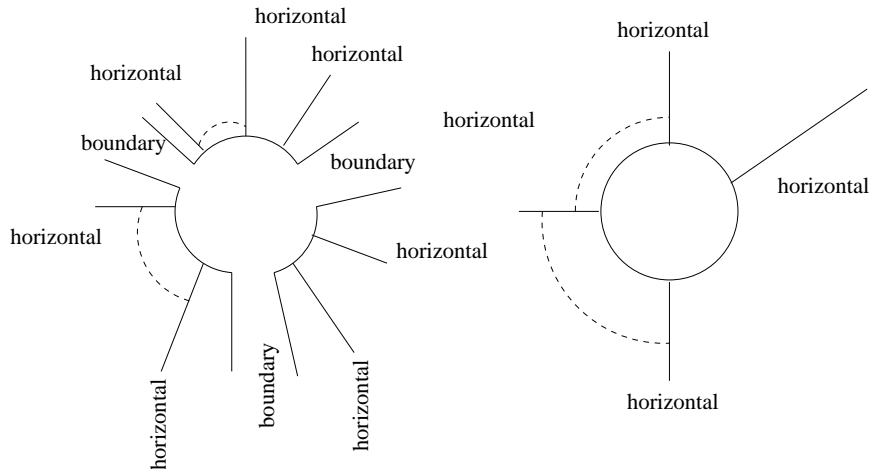

Figure 31: *Local picture of amalgamation of Heegaard splittings*

Case 2) Two N_e^i are collars of external boundary components of Seifert fibered vertex manifolds.

In this case, if all other N_e^i are empty, consider the effect of amalgamation in Example 5.5. See Figure 4. Then after an isotopy as in Figure 5, $S \cap N_e$ consists of incompressible annuli. Hence $S \cap N_e$ is as required.

Denote the two N_e^i that are collars of external boundary components of Seifert fibered vertex manifolds by N_e^1 and N_e^2 . Furthermore, denote the Seifert fibered vertex manifolds of which N_e^1 and N_e^2 are collars by M^1 and M^2 , respectively. Here, possibly, $M^1 = M^2$.

Now note that there might also be N_e^i homeomorphic to $(torus) \times I$. The main theorem in [19] states that there are two irreducible Heegaard splittings for $(torus) \times I$. One, called type I, has a splitting surface isotopic to $(torus) \times \{point\}$. The other, called type II, has a splitting surface obtained from two parallel such surfaces by ambient 1-surgery along an arc that is parallel into $\{point\} \times I$.

If M_{i_0} is homeomorphic to $(torus) \times I$ and $M_{i_0} = V_{i_0} \cup_{S_{i_0}} W_{i_0}$ is a type I Heegaard splitting, then amalgamating $M_{i_0} = V_{i_0} \cup_{S_{i_0}} W_{i_0}$ and $M_{i_1} = V_{i_1} \cup_{S_{i_1}} W_{i_1}$ just gives us back $M_{i_1} = V_{i_1} \cup_{S_{i_1}} W_{i_1}$. Thus, we will assume in what follows that none of the N_e^i 's has a type I Heegaard splitting. But note that since we may choose the foliation of the N_e^i 's as we wish, in particular, we may choose it to match up with one of the adjacent Seifert fibrations, we may still proceed as before. See Figures 32 and 33.

Thus $S \cap N_e$ is as required. \square

There are conditions that can ensure that, in fact, there can be no N_e^i homeomorphic to $(torus) \times I$ with Heegaard splittings of type II. But the argument is extremely tricky and goes beyond what is required here. To show this we would have to consider the weak reduction $M = (V_1 \cup_{S_1} W_1) \cup_{F_1} \cdots \cup_{F_{n-1}} (V_n \cup_{S_n} W_n)$ more carefully. Given a component F_i^j of some F_i , there may or may not be a 1-handle in V_{i+1} that attaches to a collar of F_i^j . If there is no such 1-handle, then, since F_i^j is incompressible, a parallel copy of F_i^j , which we denote by F_{i+1}^j , survives in F_{i+1} .

Suppose now that N_e^i is adjacent to, say, N_e^1 . Then in the Heegaard of M^1 , there is no torus parallel to the component of ∂M^1 that meets a component of ∂N_e^1 . There is, instead, a modified version of this torus, due to the existence of a 1-handle as in

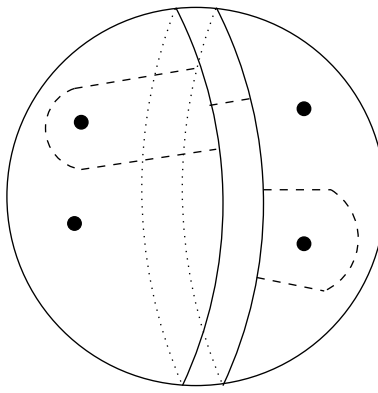

Figure 32: *Amalgamating to obtain an edge manifold*

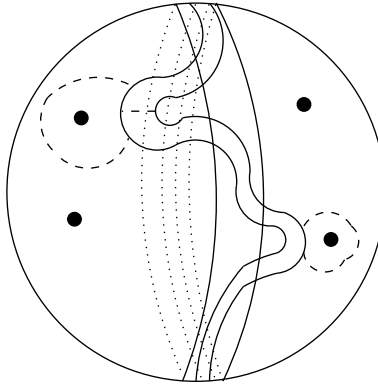

Figure 33: *Isotoping the amalgamation into place*

the preceding paragraph. The relevant 1-handle may, however, be rather elusive. It can be isotoped into M^1 . Because $S \cap M^1$ is vertical after this isotopy, it can then be shown that, under certain extra assumptions, the existence of N_e^i provides a pair of reducing disks.

References

- [1] M. Boileau, J.P. Otal: *Groupe des diffeotopies de certaines varietes de Seifert*, C. R. Acad. Sc. Paris, t. 303, Serie 1, no 1, 1986
- [2] Boileau, M., Otal, J.P.: *Scindements de Heegaard et groupes des homotopies des petites varietes de Seifert*, Invent. Math., 1991, 106, 85–107
- [3] F. Bonahon, J.P. Otal: *Scindements de Heegaard des espaces lenticulaires*, Ann. scient. Ec. Norm. Sup. 4^e serie, t. 16, 451-466
- [4] G. Burde; H. Zieschang: *Knots*, de Gruyter Studies in Mathematics, 5. Walter de Gruyter & Co., Berlin, 1985
- [5] A. Casson and C. Gordon: *Reducing Heegaard splittings*, Topology and its Applications 27 (1987) 275-283

- [6] D. Cooper; M. Scharlemann: *The structure of a solvmanifold's Heegaard splittings* Proceedings of 6th Gkova Geometry-Topology Conference. Turkish J. Math. 23 (1999), no. 1, 1–18. Or <http://arxiv.org/pdf/math.GT/9803157.pdf>
- [7] D. B. A. Epstein: *Periodic flows on 3-manifolds* Ann. Math. 95 (1972) 68-82
- [8] D. Gabai: *Foliations and the topology of 3-manifolds III*, J. Differential Geom. 26 (1987) 479-536
- [9] J. Hempel: *3-manifolds*, Annals of Mathematics Studies, Princeton University Press, Study 86, Princeton, NJ, 1976
- [10] W. Jaco: *Lectures on Three-Manifold Topology*, Regional conference series in mathematics; no. 43
- [11] Lickorish, W. B. Raymond: *An introduction to knot theory*. Graduate Texts in Mathematics, 175. Springer-Verlag, New York, 1997.
- [12] J. Milnor: *Lectures on the h-cobordism theorem*, notes by L. Siebenmann and L. Sondow, Princeton Mathematical Notes (Princeton University Press, 1965).
- [13] Y. Moriah and J. Schultens: *Irreducible Heegaard splittings of Seifert fibered spaces are horizontal or vertical*, Topology, 37 (5) 1089–1112
- [14] J. Nielsen: *Abbildungsklassen endlicher Ordnung*, Acta Mathematica 75, (1943) 23-115
- [15] Rolfsen, Dale, *Knots and links*, Corrected reprint of the 1976 original. Mathematics Lecture Series, 7. Publish or Perish, Inc., Houston, TX, 1990.
- [16] Rubinstein, J. Hyam; Scharlemann, Martin *Comparing Heegaard splittings of non-Haken 3-manifolds* Topology 35 (1996), no. 4, 1005–1026.
- [17] M. Scharlemann: *Local detection of strongly irreducible Heegaard splittings* Topology and its Applications 90 (1998) 135–147
- [18] M. Scharlemann, A. Thompson: *Thin position for 3-manifolds* AMS Contemporary Math. 164 (1994) 231–238
- [19] M. Scharlemann, A. Thompson, *Heegaard splittings of $(\text{surface}) \times I$ are standard*, Math. Ann. 295 (1993), 549-564
- [20] J. Schultens, *The Classification of Heegaard splittings for $(\text{closed orientable surface}) \times S^1$* , London Math. Soc. (3) 67 (1993) 425-448
- [21] J. Schultens, *Heegaard splittings of Seifert fibered spaces with boundary*, Trans. Amer. Math. Soc. 347 (1995), no. 7, 2533–2552.
- [22] J. Schultens, *Weakly reducible Heegaard splittings of Seifert manifolds are vertical*, Topology Appl. 100 (2000), no. 2-3, 219–222.
- [23] J. Schultens, *Additivity of Tunnel Number for Small Knots*, Comment. Math. Helv. 75 (2000), no. 3, 353–367.

- [24] J. Schultens, R. Weidmann, *On the geometric and algebraic rank of graph manifolds*, preprint
- [25] Thurston, William P. Edited by Silvio Levy. *Three-dimensional geometry and topology. Vol. 1* Princeton Mathematical Series, 35. Princeton University Press, Princeton, NJ, 1997. x+311 pp. ISBN: 0-691-08304-5
- [26] R. Weidmann, ??? to appear in Arch. Math.